

FLOREN PENDANT TWO

FINISH

antique brass with ribbed glass shade

DIMENSIONS (body of fixture)

2055 x 200 x 410 mm (w x d x h)

WEIGHT

5kg (11lbs)

please ensure ceiling structure is strong enough to support the weight of the light

OVERALL DROP

minimum 660 mm

maximum on request 6460 mm

supplied with 1000 mm drop rod

ILLUMINATION

220-240v - 2 x E27 - 60w max (or 8w LED 2700k)

110-130v - 2 x E26 - 60w max (or 8w LED 2700k)

DIMMING

dimnable bulb required

trailing edge dimmable / phase cut (rotary dimmer) - standard

DALI option available (220-240v only)

CEILING ROSE / PLATE

round ceiling rose - \varnothing 105 x 50 mm (dia x h)

CERTIFICATION

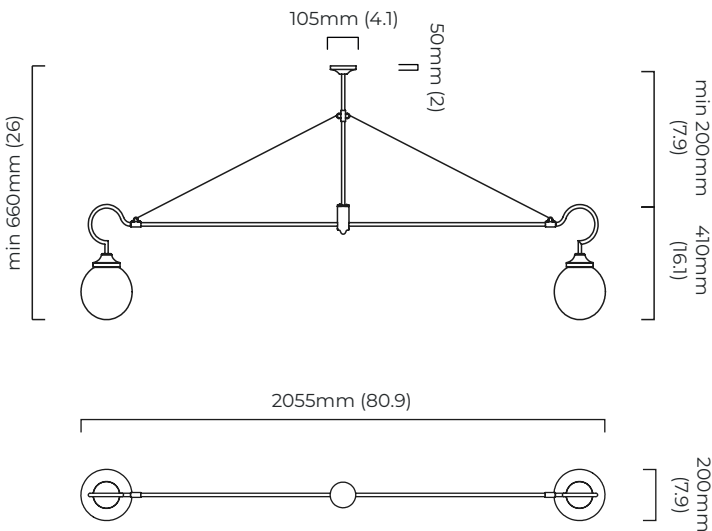

mounting plate dimensions

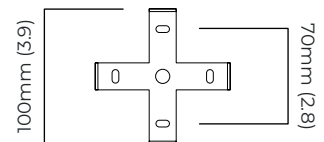

*Diagrams are not to scale.

SKU NUMBER	FINISH DESCRIPTION	VOLTAGE
FLOPE2ABRG-240	antique brass with ribbed glass shade	220 - 240V
FLOPE2ABRG-110	antique brass with ribbed glass shade	110 - 130V

FLOREN PENDANT TWO - DALI-A

FINISH

antique brass with ribbed glass shade

DIMENSIONS (body of fixture)

2055 x 200 x 410 mm (w x d x h)

WEIGHT

5kg (11lbs)

please ensure ceiling structure is strong enough to support the weight of the light

OVERALL DROP

minimum 660 mm

maximum on request 6460 mm

supplied with 1000 mm drop rod

ILLUMINATION

220-240v - 2 x E27 - 60w max (or 8w LED 2700k)

DALI converter to be installed in the cavity

DIMMING

dimnable bulb required

DALI compatible

CEILING ROSE / PLATE

round ceiling rose - \varnothing 105 x 50 mm (dia x h)

CERTIFICATION

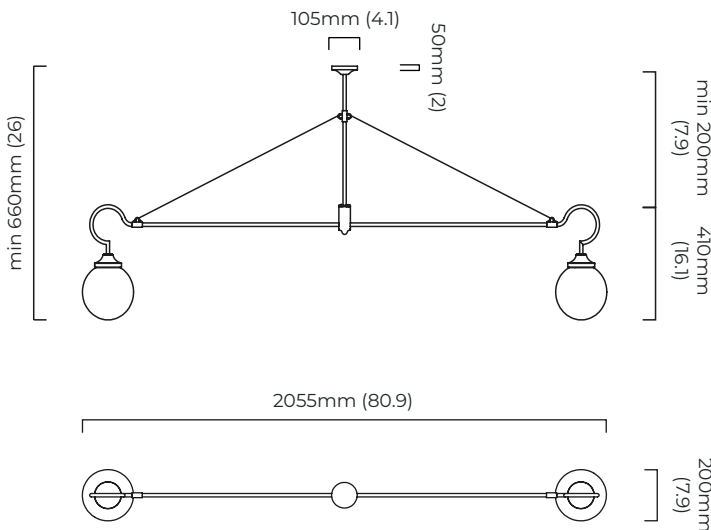

mounting plate dimensions

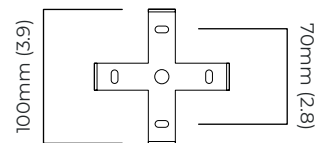

DALI converter dimensions

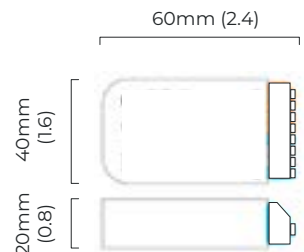

*Diagrams are not to scale.

SKU NUMBER	FINISH DESCRIPTION	TYPE OF DALI	VOLTAGE
FLOPE2ABRG-DALIA-240	antique brass with ribbed glass shade	DALI A included - For lights that do not require aesthetic alterations. Dalí can be fitted inside the ceiling/wall cavity	220 - 240V

FLOREN PENDANT TWO - DALI-B

FINISH

antique brass with ribbed glass shade

DIMENSIONS (body of fixture)

2055 x 200 x 410 mm (w x d x h)

WEIGHT

5kg (11lbs)

please ensure ceiling structure is strong enough to support the weight of the light

OVERALL DROP

minimum 645 mm

maximum on request 6445 mm

supplied with 1000 mm drop rod

ILLUMINATION

220-240v - 2 x E27 - 60w max (or 8w LED 2700k)

DALI converter to be installed in the ceiling rose

DIMMING

dimnable bulb required

DALI compatible

CEILING ROSE / PLATE

round ceiling rose - \varnothing 140 x 35 mm (dia x h)

CERTIFICATION

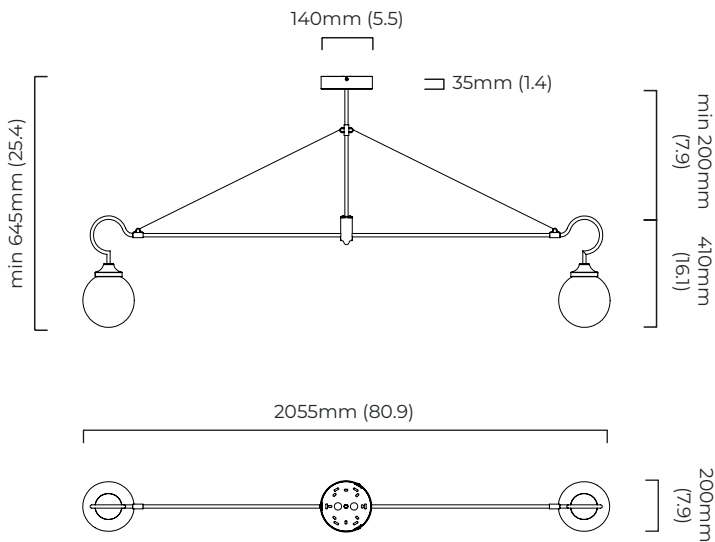

mounting plate dimensions

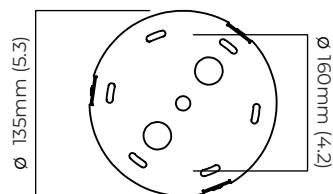

*Diagrams are not to scale.

SKU NUMBER	FINISH DESCRIPTION	TYPE OF DALI	VOLTAGE
FLOPE2ABRG-DALIB-240	antique brass with ribbed glass shade	DALI B included - The light will feature a deeper ceiling/wall rose. For use when there is no space in the existing ceiling/wall cavity.	220 - 240V