

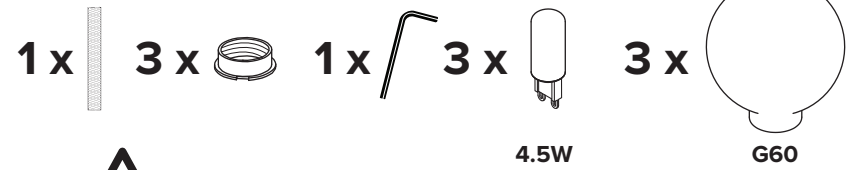

# WALDORF TRIPLE

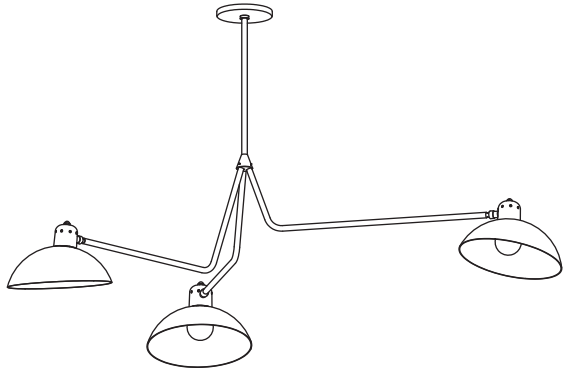



- To be installed by an electrician to an electrical box
- Use appropriate screws and anchors where necessary
- Wear enclosed gloves when handling lamp
- Handle materials with care. Please consult lamp maintenance sheet on our web site



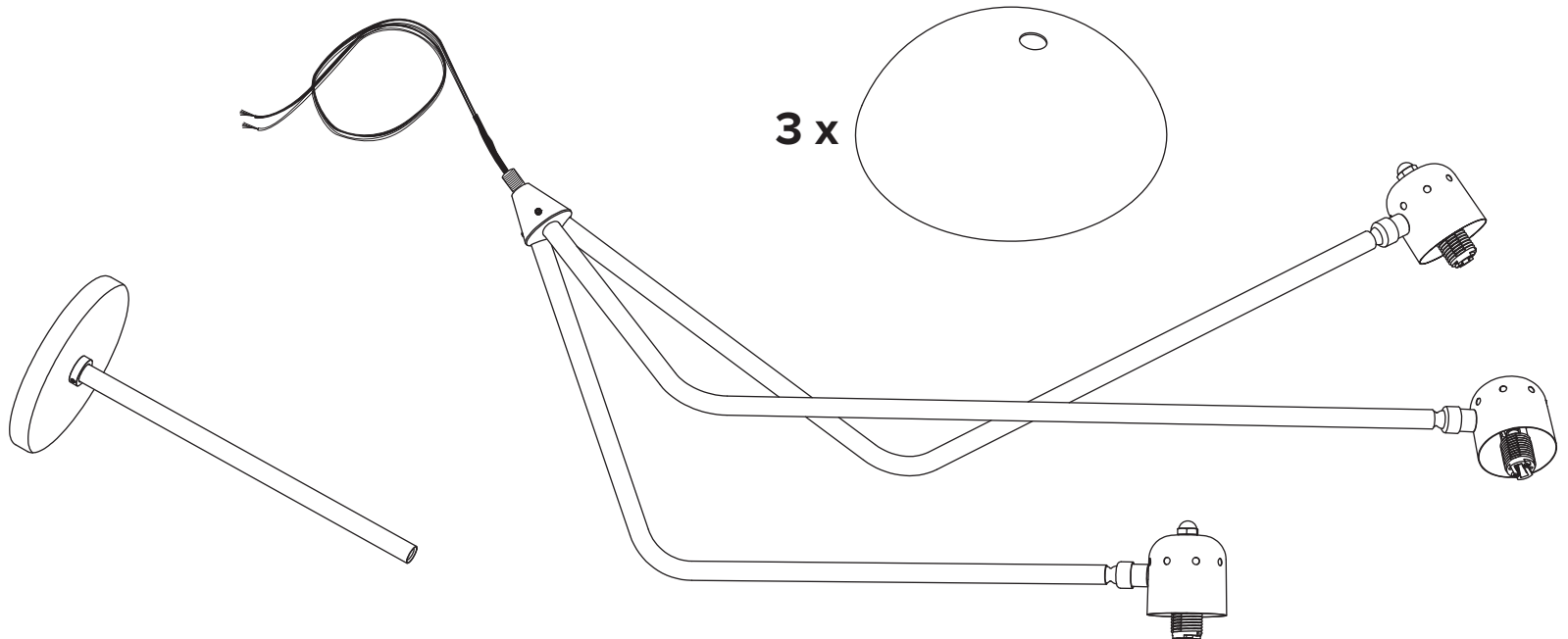



**Important steps to follow when installing a glass globe**

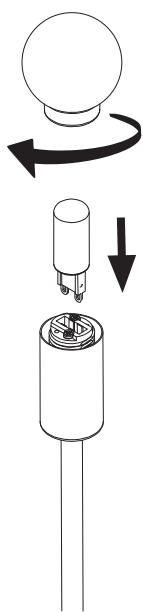

Insert bulb.

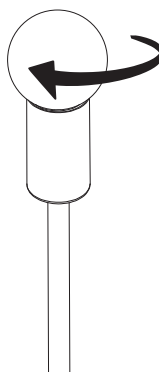

Screw in globe gently until it is tight.  
Do not force the globe.

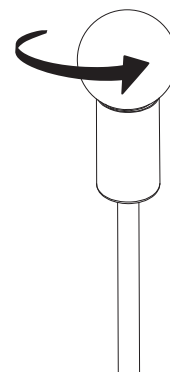

Unscrew bulb slightly 1/2 turn.

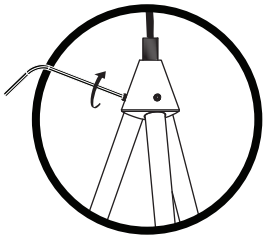

Loosen set screw, position arm,  
re-tighten set screw.  
Do not pull on arm.

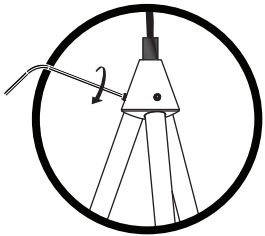

\* Screw gently, but firmly

1

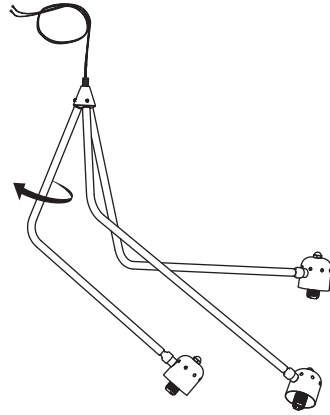

2

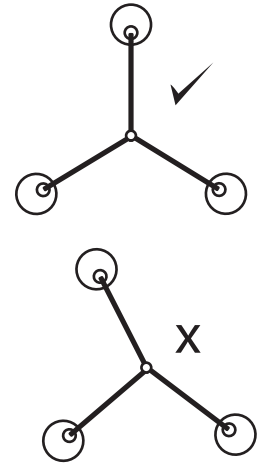
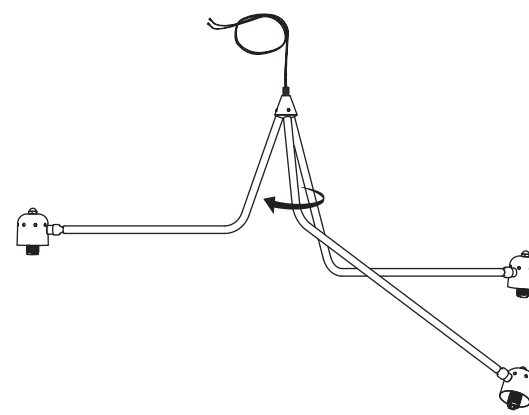

3

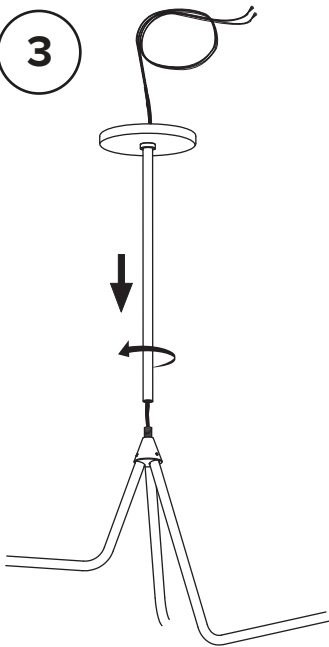

4

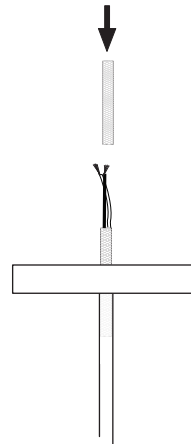

5

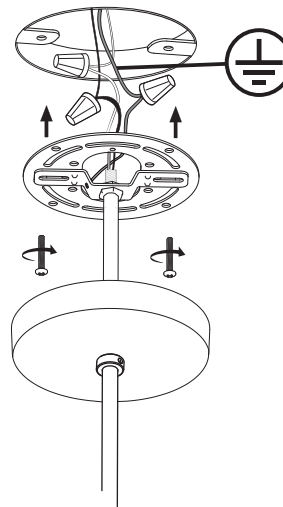

6

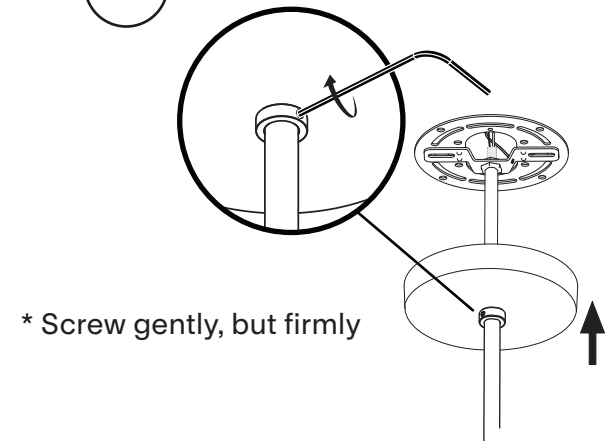

\* Screw gently, but firmly

7

