

# Silo 4V



As modular and versatile as the collection itself, Silo makes its debut as an object. A flower vase and candle holder hybrid. From one end, water-resistant extrusions accommodate fresh cut flowers. Flip it over, and it becomes the perfect candle holder.

<b>TYPE</b>	Vase and candle holder
<b>CONSTRUCTION</b>	Powder coated, mirror polished or tumbled aluminum body
<b>USAGE</b>	The Silo Vase can be used as a flower vase on one end or a candle holder on the other end
<b>WEIGHT</b>	Shape J: 3.2 lb / 1.45 kg Shape K: 3.9 lb / 1.77 kg

SIL4VJ

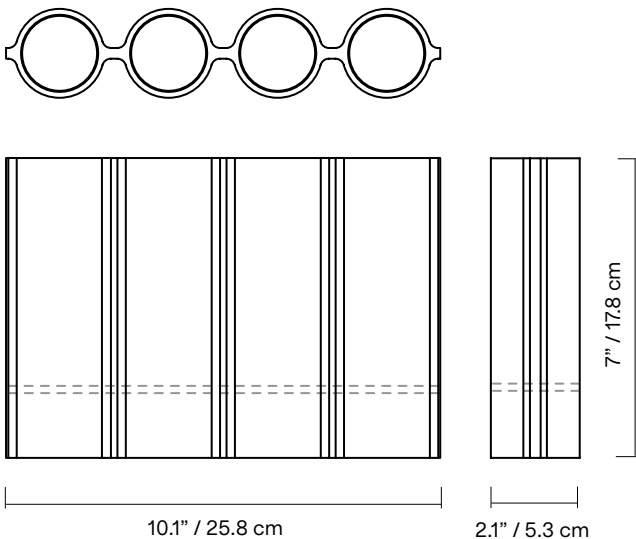

SIL4VK

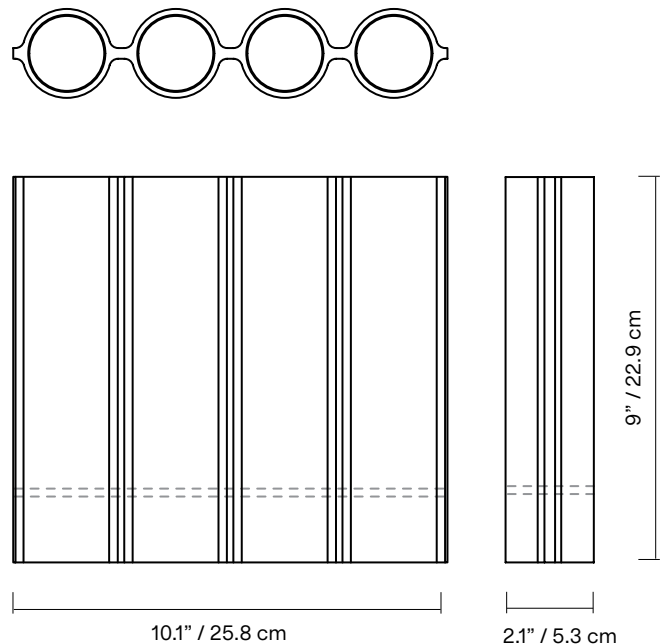

\*dimensions are approximate and may vary slightly

## FINISH



**BK**  
Textured  
black



**WH**  
Textured  
white



**MR**  
Mirror  
polished



**TA**  
Tumbled  
aluminum



**BG**  
Textured  
beige



**DP**  
Wrinkled  
dusty pink



**TC**  
Textured  
terracotta



**OB**  
Glossy  
oxblood



**AU**  
Textured  
aubergine



**MB**  
Textured  
midnight blue

## NOTES

- Additional charges for modifications or for special orders

## VASE ANATOMY

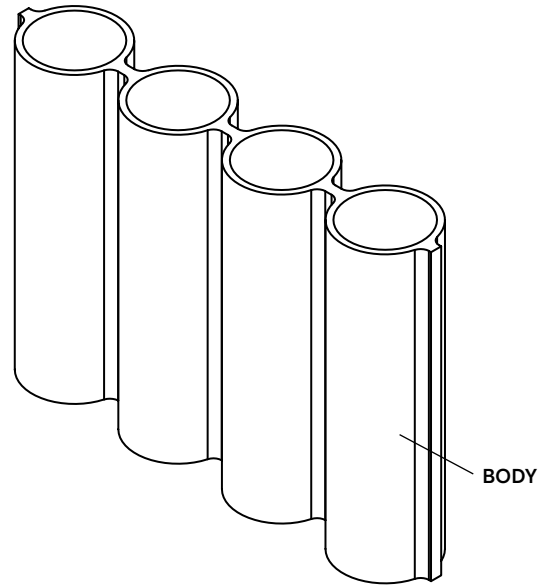

		Example	Fill with your selection
<b>COLLECTION</b>	<b>SIL</b> Silo	<b>SIL</b>	<b>SIL</b>
<b>MODEL</b>	<b>4V</b>	<b>4V</b>	<b>4V</b>
<b>SHAPE</b>	<b>J</b> 7" <b>K</b> 9"	<b>J</b>	
<b>BODY</b>	<b>AU</b> Textured aubergine <b>BG</b> Textured beige <b>BK</b> Textured black <b>DP</b> Wrinkled dusty pink <b>MB</b> Textured midnight blue <b>MR</b> Mirror polished aluminum <b>OB</b> Glossy oxblood <b>TA</b> Tumbled aluminum <b>TC</b> Textured terracotta <b>WH</b> Textured white <b>CC</b> Custom colour*	<b>AU</b>	
<b>FULL SKU</b>		<b>SIL4VJAU</b>	
		<b>NOTES</b>	

\*Custom colour available upon request. Material library on website.