

Isle 10







ISLE 10 - COLOUR PALETTE 1

ISL03A: Black Marquina + Polished Aluminum + Black Marquina

ISL02A: Polished Aluminum + Black Marquina

An ode to quiet strength, Isle is a play both on illusion and perception allowing lightness to anchor and foundations to rise. Composed of a delicate glass tube resting on solid-stone and aluminum pedestals and suspended in mid-air like a surreal bridge, Isle is minimal, but never simplistic.

TYPE	Suspension
CONSTRUCTION	Frosted glass tube Polished aluminum or marble block and slab Polished aluminum endcap, canopy and anchors Polyester cord
SPECIFICATIONS	Power consumption: 52W Colour temperature: 3000K 2700K dim to warm 3000K to 2200K dim to warm 2700K to 2200 Lumen output: 2700K - 2815 lm Colour rendering index: ≥90 CRI Colour consistency: 3 SDCM Expected lifetime: ≥50 000h
CONTROL	120/277V on/off, 0-10V, or phase dimming 220-240V: On/Off, Phase Dimming, DALI Refer to our recommended list of dimmer models on page 6
CORD LENGTH	Mains/line cords- 120" / 304 cm Non-electrical cords- 96" / 244 cm
WEIGHT	ISL02A- 13.5lb / 6.1Kg ISL03A- 17.5lb / 7.9Kg
CERTIFICATIONS	     IP20
WARRANTY	2 years

NOTES

- The canopy can be offset from composition.
- Luminaire total height (ceiling to lowest point of luminaire)
Min - 32"/81 cm
Max - 102"/259 cm
*For any height outside these parameters, contact Lambert & Fils
- For installation on slanted ceiling, contact Lambert & Fils
- Ceiling anchors can be used as junction boxes for daisy chain. If needed, please inform your representative.
- Dimensions are approximate and may vary slightly

The canopy cannot be installed in the center of the proposed composition.

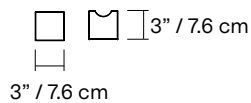
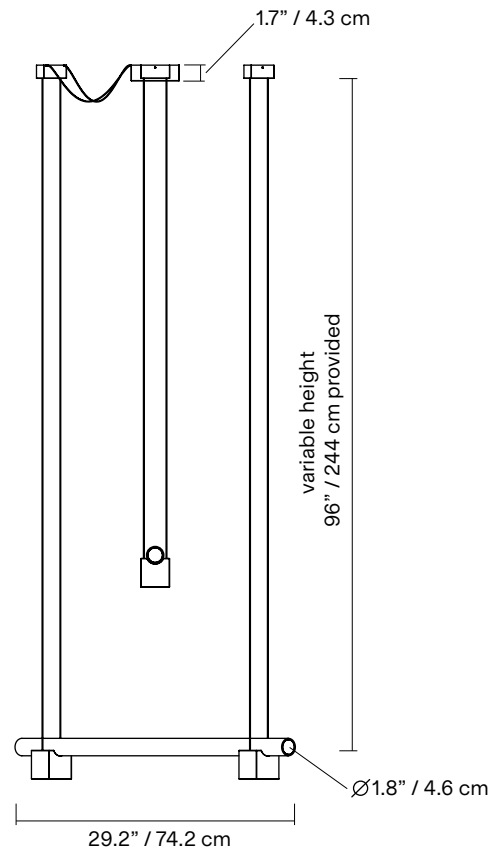
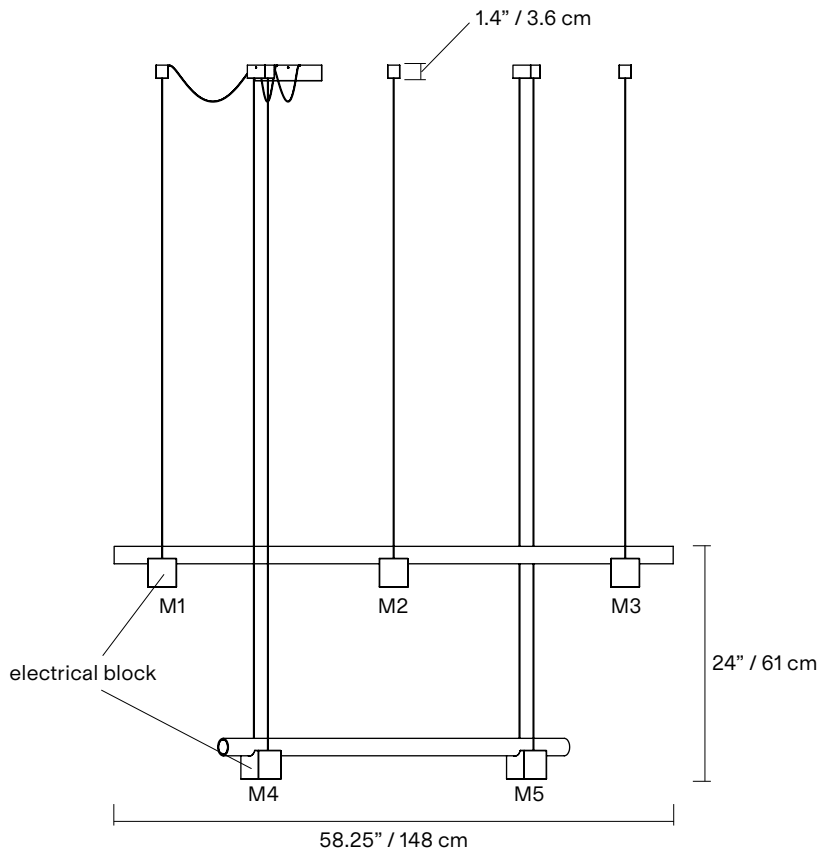
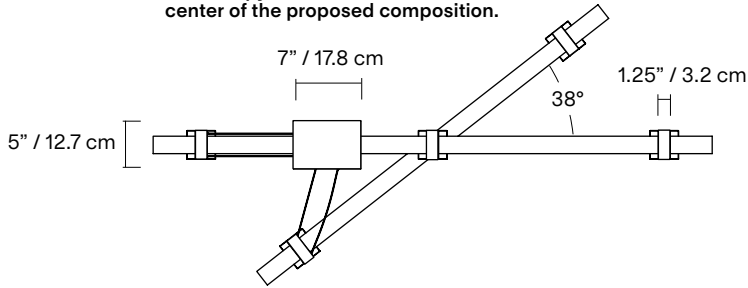

SM- Surface mounted

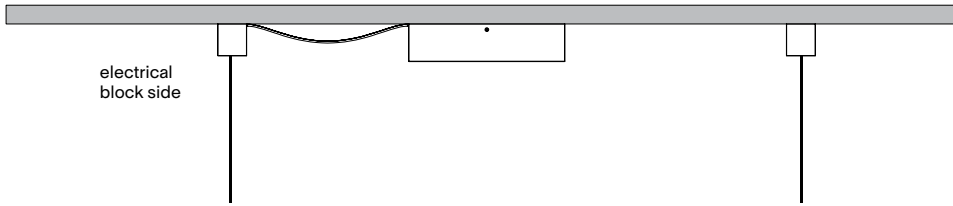

RM-Remote driver

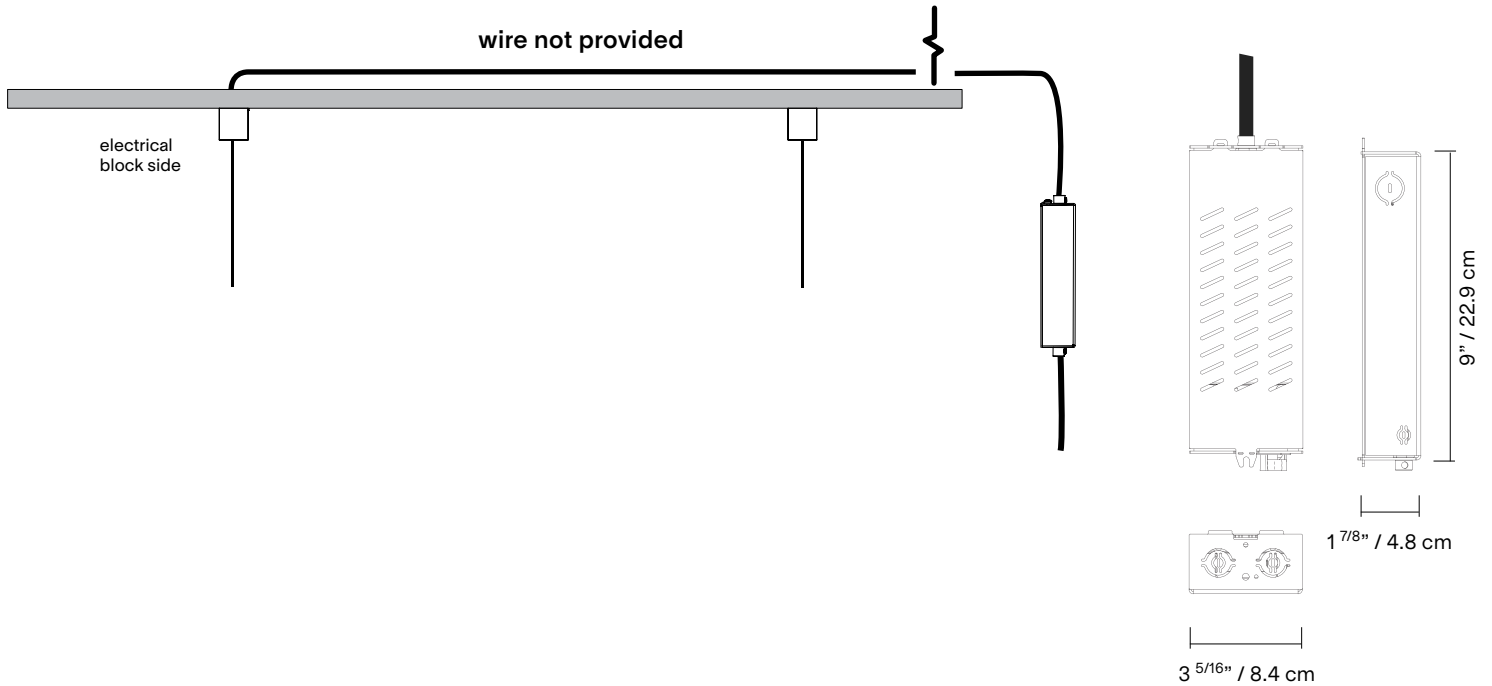

*housing not necessary for Phase Dimming 220-240VAC (only driver provided)

REMOTE DRIVER HOUSING

Must be accessible for maintenance in a well aerated location for heat dissipation

Use the following chart to determine proper wiring gauge according to the distance to its location.

GAUGE

18AWG (0.75mm²)
 16AWG (1.5mm²)
 14AWG (2.5mm²)
 12AWG (4mm²)

MAX ALLOWABLE DISTANCE

85 ft. / (26 m)
 136 ft. / (41 m)
 216 ft. / (66 m)
 343 ft. / (105 m)

MATERIAL

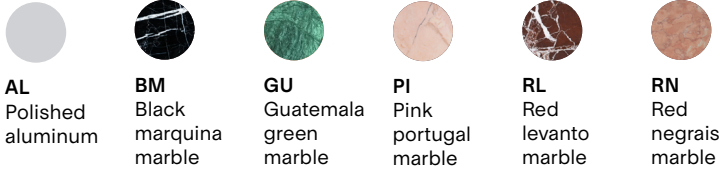

CORD



MOUNTING

SM
Surface mounted

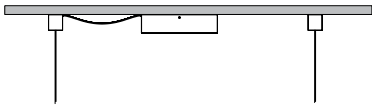

RM
Remote Driver

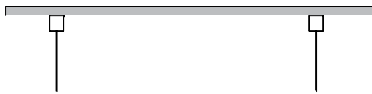

NOTES

- Must be installed by an electrician
- LED may only be changed by Lambert & Fils or other authorized personnel
- Not protected against liquids (refer to IP20)
- Additional charges for modifications or for special orders
- Please refer to maintenance sheet on our website for cleaning instructions

LAMP ANATOMY

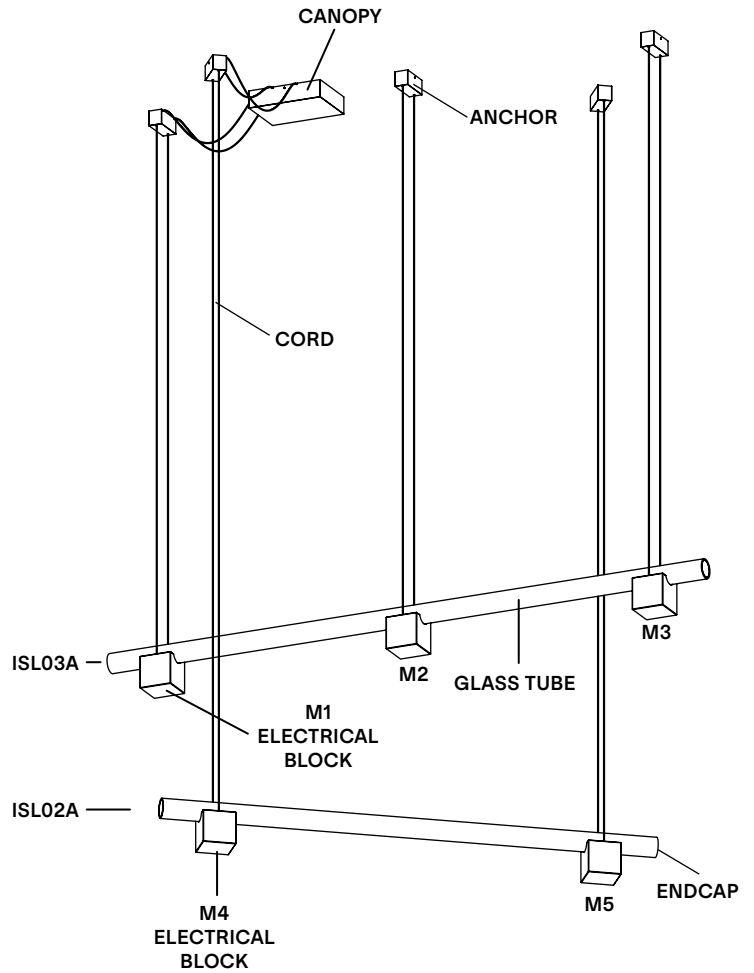

		Example	Fill with your selection
COLLECTION	ISL Isle	ISL	ISL
MODEL	10	10	10
MATERIAL	<p>P1 ISL03A - Black Marquina (M1) + Polished aluminum (M2) + Black Marquina (M3) ISL02A - Black Marquina (M4) + Polished aluminum (M5)</p> <p>P2 ISL03A - Red Levanto (M1), Polished Aluminum (M2), Guatemala Green (M3) Guatemala Green (M4), Polished Aluminum (M5)</p> <p>P3 ISL03A - Polished Aluminum (M1+M2), Red Negrais (M3) Pink Portugal (M4) + Polished Aluminum (M5)</p> <p>P4 ISL03A - Pink Portugal (M1) + Polished Aluminum (M2) + Red Levanto (M3) Red Levanto (M4) + Polished Aluminum (M5).</p>	P1	
CORD	BK Black	BK	BK
CANOPY AND ANCHORS	AL Polished aluminum	AL	AL
MOUNTING	SM Surface mounted RM Remote driver	SM	
COLOUR TEMPERATURE (CCT)	WL Warm light (2700K) NL Neutral light (3000K) D27 Dim to warm (2700K-2200K) D30 Dim to warm (3000K-2200K) CCT Other CCT available upon request*	WL	
DIMMING	ZT 0-10V (120VAC only) PH Phase dimming DA DALI (220-240VAC only)	ZT	
FULL SKU		ISL10P1BKALSMWLZT	

NOTES

*Specific CCT selection only available in 100k increments, from 2200K to 4000K inclusively and not available with Dim-to-Warm feature.

TESTED DIMMER COMPATIBILITY LIST - 120V

Compatible with Trailing Edge dimming (Reverse Phase/ELV) or Leading Edge (Forward Phase) dimming.
We strongly recommend using dimmers that require a Neutral wire connection.

DIMMER BRAND	MODEL	MAX LEVEL	MIN LEVEL	DIMMING PROTOCOL
Lutron Diva	DVELV-300P	100%	1%	Phase Cut
Lutron Diva	DVELV-303P	100%	1%	Phase Cut
Lutron Diva	DVRP-253P	100%	1%	Phase Cut
Lutron Skylark	CTELV-303P	100%	1%	Phase Cut
Lutron Skylark	SELV-300P	100%	1%	Phase Cut
Lutron Skylark	SELV-303P	100%	1%	Phase Cut
Lutron Skylark	CTRP-253P	100%	1%	Phase Cut
Lutron Maestro	MA-PRO	100%	1%	Phase Cut
Lutron Caseta	PD-5NE	100%	1%	Phase Cut
Lutron Nova	NTELV-300	100%	1%	Phase Cut

Some dimmers require a minimum load, check specifications.

We recommend conducting your own test before final installation.
