

# STORM MEDIUM EXTENSION S350

## DATA

Collection	STORM SYSTEM®
Product	Storm Medium Extension S350
Article no.	1A01.0035.xx

## SPECIFICATIONS

Weight	1481 g / 3165 g
Load	max. 10 kg
Material	Aluminium / Brass
Fixture finish	For xx-codes review STORM SYSTEM® – COLOUR CODES >

## ADDITIONAL REQUIREMENTS

Fixture	Product from the STORM SYSTEM® MEDIUM collection
---------	--

## NOTE

This product is compatible with European Standard Box – 60mm screw distance



## STORM SYSTEM®

The Storm Medium Extension S350 is part of the STORM SYSTEM® MEDIUM collection. A collection that includes a wide range of special designed products. The STORM SYSTEM® collection is carefully designed to flush the surface of any ceiling or wall, and all products will appear with an absolute minimum of tolerance and visibility.

Storm Medium Extension S350 is designed for ceilings with no build-in depth. The fixture makes it possible to mount the STORM SYSTEM® MEDIUM collection on to any kind of ceiling.

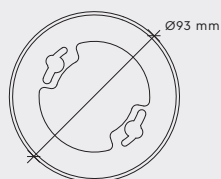

#### IMPORTANT INFORMATION

Installation and mounting must be performed by skilled personnel only, and instructions must be followed.

#### CLEANING AND MAINTENANCE:

Use a soft moist cloth for cleaning. No further maintenance is required.

#### WARRANTY:

If the product is defect, please contact your supplier immediately. Please note that warranty will not apply in case of wrongful use or if unskilled personnel attempts to repair.

#### COMPONENTS

- Storm Medium CC Base
- Storm Medium Extension S150/S350

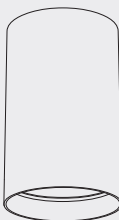

#### PLEASE NOTE:

If the spring on the fixture is damaged, do not proceed installation – contact your dealer!

## STORM MEDIUM EXTENSION S150/S350

### ASSEMBLY INSTRUCTION

#### STEP 1

Mount the fixture onto the ceiling, by placing the Storm CC Base over the screws and slightly rotating, then tighten the screws.

The fixture is compatible with

- European standard box – 60mm screw distance

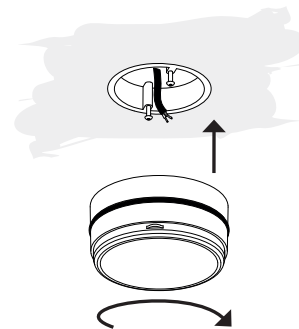

Assembly without standardbox

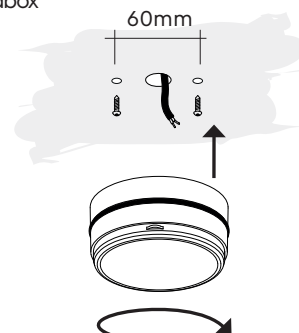

#### STEP 2

Then mount the Storm Extension S150/S350 tube onto the Storm CC Base, by gently rotating into place.

NOTE: When rotating the fixture choose the direction with the least resistance.

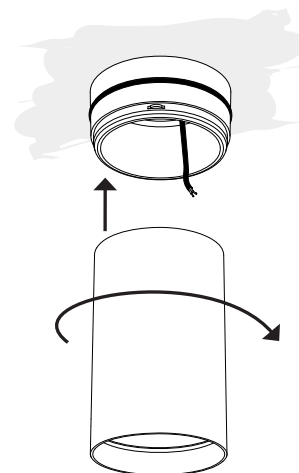

#### STEP 3

Mount the chosen fixture/light source according to the accompanying assembly instructions

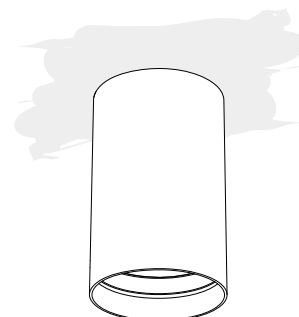

**IMPORTANT INFORMATION**

Disassembly must be performed by skilled personnel only, and instructions must be followed.

**WARRANTY:**

If the product is defect, please contact your supplier immediately. Please note that warranty will not apply in case of wrongful use or if unskilled personnel attempts to repair.

# STORM MEDIUM EXTENSION S150/S350

## DISASSEMBLY INSTRUCTION

**STEP 1**

Disconnect the bottom fixture according to the fixtures disassembly instruction's.

**STEP 2**

To dismantle, gently pull down on the Storm Extension S150/S350 Tube, whilst slightly rotating.

**NOTE:** When rotating the fixture choose the direction with the least resistance.

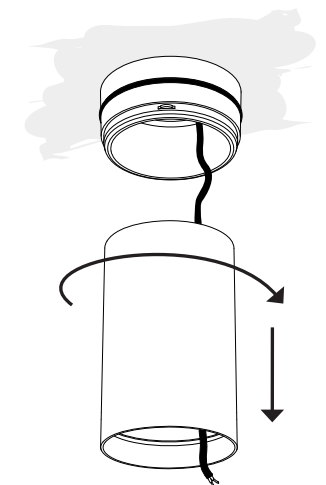
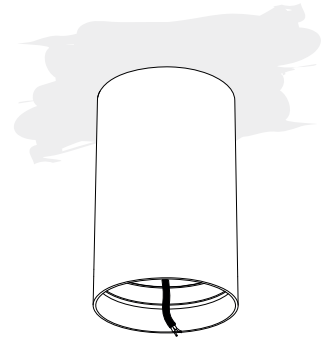

**STEP 2**

Loosen the screws, then slightly rotate and gently pull down.

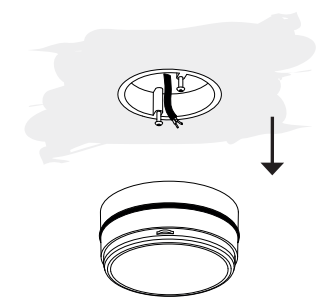

Assembly without standardbox

