

## STORM SYSTEM®

The Storm Small Art is part of the STORM SYSTEM® collection. A collection that includes a wide range of special designed products. The STORM SYSTEM® collection is carefully designed to flush the surface of any ceiling or wall, and all products will appear with an absolute minimum of tolerance and visibility.

The Storm Small Art is designed to rotate 350° and angles 90°. A honeycomb louvre is placed inside the spot to avoid glaring.

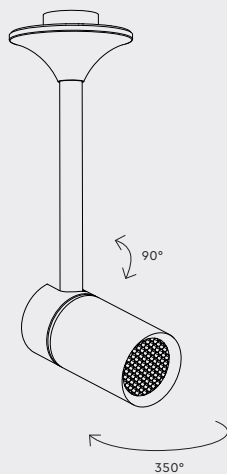
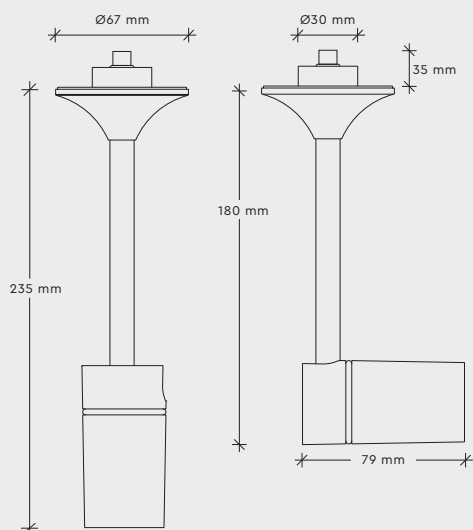

The crossed-out wheeled bin symbol indicates that the item should be disposed of separately from household waste. The item should be handed in for recycling in accordance with local environmental regulations for waste disposal

For more information, please contact [info@onea.dk](mailto:info@onea.dk)

# STORM SMALL ART DIM

## DATA

Collection	STORM SYSTEM®
Product	Storm Small Art – dim
Article no.	1A00.0155.xxyy

## SPECIFICATIONS

Weight	421 g
Materials	Aluminium / Brass
IP protection grade	IP20
Labelling	CE
Safety distance	0,3m
Insulation class	Class III
Fixture finish	For xx-codes review STORM SYSTEM® – COLOUR CODES >
Light source	LED Constant Current (light source included)
Supply	5W   35V   130mA

## YY CODES – light sources

65 – 2700K, 30°

67 – 3000K, 30°

For IES/LDT lux files review STORM SYSTEM® – LUX FILES >

NOTE: when using honey combs the light output will fall with 30% in efficiency

## ADDITIONAL REQUIREMENTS

Driver review CONFIGURATION >

This product shall always be powered by SELV LED driver, output voltage of this driver in open circuit must not exceed 60V. Do NOT cover the LED driver

## OPTIONAL ACCESSORIES

1AL.B01 – 18° lens

1AL.B03 – 50° lens

## NOTE

The light source contained in the fixture must only be replaced by the manufactures

## IMPORTANT INFORMATION

Installation and mounting must be performed by a certified electrician only, and instructions must be followed.

Always make sure the main power is off during installation. Pay attention to the fixture remarks, and always make sure to use the correct voltage.

## CLEANING AND MAINTENANCE:

Use a soft moist cloth for cleaning. No further maintenance is required.

## WARRANTY:

If the product is defect, please contact your supplier immediately. Please note that warranty will not apply in case of wrongful use or if unskilled personnel attempts to repair.

## COMPONENTS

- Storm Small Art

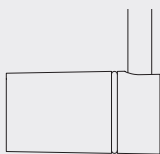
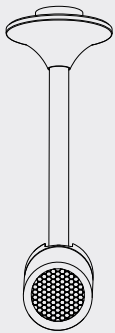

# STORM SMALL ART

## ASSEMBLY INSTRUCTION

### STEP 1

Connect the wires. Push the wires inside the junctionbox.

**BE ATTENTIVE!** Make sure you are using the correct power supply according to the fixture.

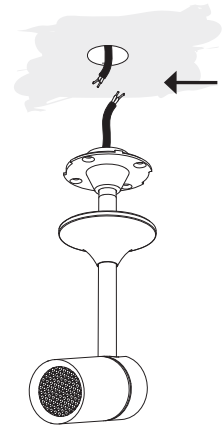

### STEP 2

Mount the fixture onto the ceiling or wall. Then gently slide the cover towards the base and rotate slightly for fixation.

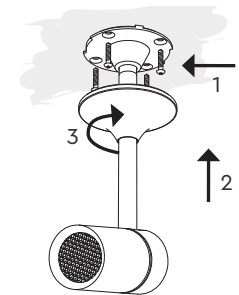

### STEP 3

Adjust the fixture to the desired position.

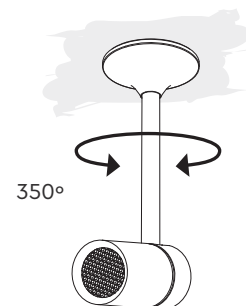

#### IMPORTANT INFORMATION

Disassembly must be performed by a certified electrician only, and instructions must be followed.

#### WARRANTY:

If the product is defect, please contact your supplier immediately. Please note that warranty will not apply in case of wrongful use or if unskilled personnel attempts to repair.

## STORM SMALL ART

### DISASSEMBLY INSTRUCTION

#### STEP 1

Rotate slightly to unfasten the cover, then gently slide the cover down.

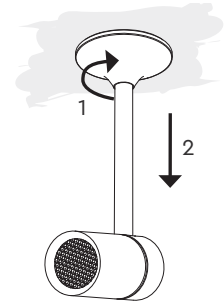

#### STEP 2

Unscrew the fixture from the ceiling or wall.

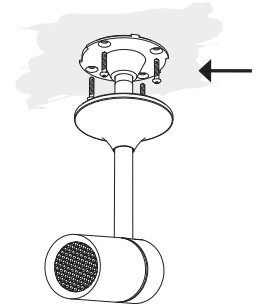

#### STEP 3

Disconnect the cables.

