



STORM MEDIUM SECURITY PIR VDS datasheet



Project: ONE A Showroom | Lighting design: ONE A

The STORM SYSTEM® collection is carefully designed to flush the surface of any ceiling or wall, and all products will appear with an absolute minimum of tolerance and visibility.

Storm Medium Security Pir is a motorized unit which elevates the included alarm pir – in and out of the ceiling, controlled by the main alarm system. With Storm Medium Security Pir you can enjoy the benefit of having an invisible alarm pir, as they are only visible when the alarm system is on. Storm Medium Security Pir can be managed by various wired alarm systems.

GENERAL DATA

Collection

STORM SYSTEM®

Product

Storm Medium Security Pir VDS

Article no.

- 1A01.1254.xx

SPECIFICATIONS

Weight

650 g

Material

Aluminium, steel,
polycarbonate and
electronics

IP protection grade

IP20

Labelling

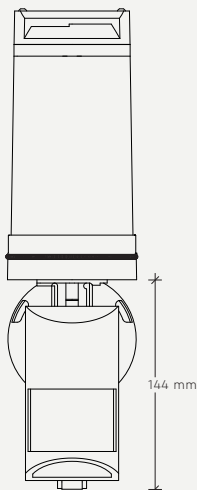
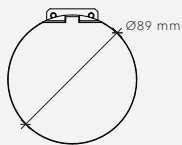
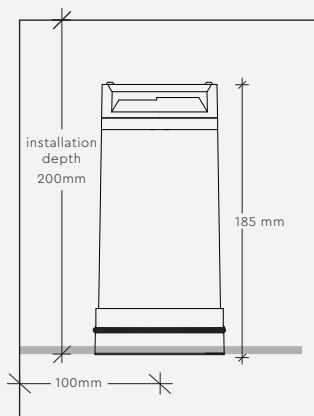

FEATURES

- Passive infrared motion detector
- 3-Brid gliding focus mirror optics
- Sealed optics
- Autofocus with constant range sensitivity
- Mighty angular deviation of walls

ELECTRICAL SPECIFICATIONS

Pir

Aritech VE1012-D (included)
12Vdc (9-15V)

Motor

12Vdc (9-30V),
stationary: 19mA@12V
moving: 430mA@12V

Ceiling height

2,3 - 3 m

ADDITIONAL REQUIREMENTS: (not included)

Installation rings - choose one of the installation rings below

- Storm Medium Plaster Ring - 1A01.0001.01
- Storm Medium Acoustic Adaptor - 1A01.0091.00
- Storm Medium Back-Mounted Ring - 1A01.0048.xx
- Storm Medium Back 007 Ring - 1A01.0047.xx

XX - COLOUR CODES



01 - White



92 - Black Pearl

NOTE

Storm Medium Security is a building part which includes a standard PIR from Aritech. Installation must be supervised by an alarm integrator who is responsible for correct installation.

Due to product elevation, extended alarm activation may be necessary.

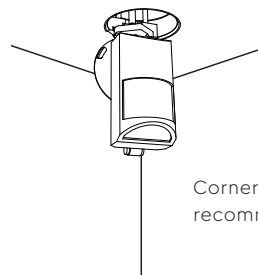

Corner position
recommended



WIRING OVERVIEW

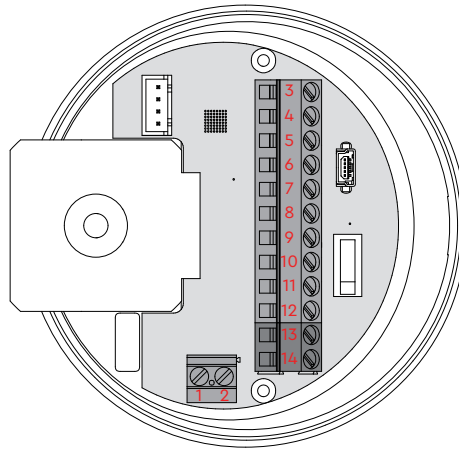

| | | |
|---------|----|--|
| retract | 1 | Common |
| retract | 2 | 0V = extend, 9-30V = retract |
| TROUBLE | 3 | Common |
| TROUBLE | 4 | Closed = fully extended, open = moving or trouble detected |
| UNUSED | 5 | No connection |
| UNUSED | 6 | No connection |
| TAMPER | 7 | Common |
| TAMPER | 8 | Tamper signal from both PIR sensor and Storm security |
| ALARM | 9 | Common |
| ALARM | 10 | Alarm signal directly from PIR sensor |
| + | 11 | Supply for PIR sensor 9-15Vdc (4,4mA Norm) |
| - | 12 | GND for PIR |
| + | 13 | Supply Storm Security 9-30V (19mA @12V, max 420mA @12V when moving) |
| - | 14 | GND Storm Security supply |

Up and down signal (1+2) polarity of control signal does not matter. Retract signal: 9-30Vdc, 10K ohm input impedance (Note: this input must be controlled by either gold plated contacts or solid state output, due to the low current draw.)

The Trouble signal (3+4) indicates the status of the Storm security device, only when the unit is fully extended and everything is OK, will the trouble terminals change to the closed (shorted) state. While the unit is retracted or moving the trouble terminals will be open.

The tamper signal (7+8) are shared between the PIR sensor and the Storm Security device (In Daisy Chain), the tamper signal is normally closed (shorted), in case of tamper detection on either the PIR sensor or the Storm security device the tamper signal will be open.

ASSEMBLY INSTRUCTION

page 1 of 2

STEP 1

Unscrew the screws, and gently lift the lid off.
Then connect the appropriate cables according to the diagram on the previous page.

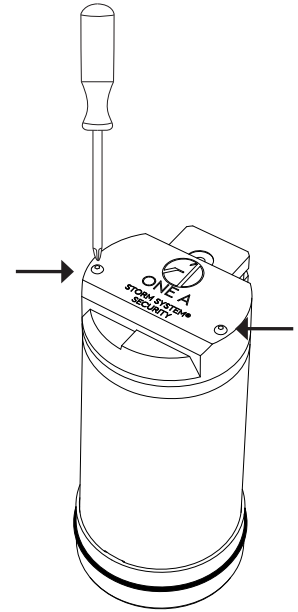

STEP 2

Replace the lid.

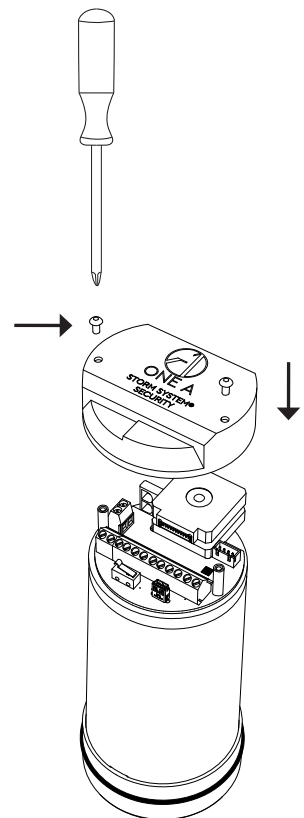

IMPORTANT INFORMATION

Installation and mounting must be performed by a certified electrician only, and instructions must be followed. Always make sure the main power is off during installation. Pay attention to the fixture remarks, and always make sure to use the correct voltage.

CLEANING AND MAINTENANCE:

Use a soft moist cloth for cleaning. No further maintenance is required.

WARRANTY:

If the product is defect, please contact your supplier immediately. Please note that warranty will not apply in case of wrongful use or if unskilled personnel attempts to repair.



The crossed-out wheeled bin symbol indicates that the item should be disposed of separately from household waste. The item should be handed in for recycling in accordance with local environmental regulations for waste disposal

For more information, please contact info@onea.dk

ASSEMBLY INSTRUCTION

page 2 of 2

STEP 3

Mount the fixture into the installation ring. Do this by slightly rotating the fixture into the installation ring.

NOTE: When rotating the fixture choose the direction with the least resistance.

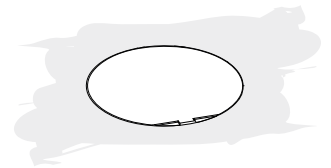
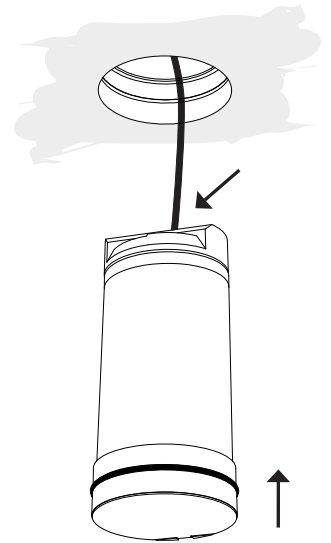

STEP 4

Gently open the lid, and rotate the fixture, so that the sensor is positioned correctly.

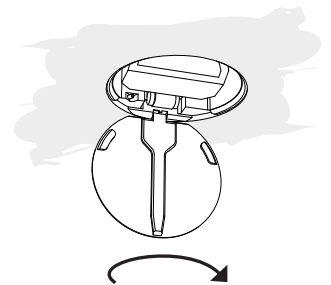

STEP 5

Use the accompanying allen key and tighten the screw to ensure that the fixture cannot be rotated.

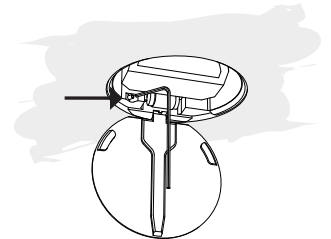

IMPORTANT INFORMATION

Installation and mounting must be performed by a certified electrician only, and instructions must be followed. Always make sure the main power is off during installation. Pay attention to the fixture remarks, and always make sure to use the correct voltage.

CLEANING AND MAINTENANCE:

Use a soft moist cloth for cleaning. No further maintenance is required.

WARRANTY:

If the product is defect, please contact your supplier immediately. Please note that warranty will not apply in case of wrongful use or if unskilled personnel attempts to repair.



The crossed-out wheeled bin symbol indicates that the item should be disposed of separately from household waste. The item should be handed in for recycling in accordance with local environmental regulations for waste disposal

For more information, please contact info@onea.dk

DISASSEMBLY INSTRUCTION

STEP 1

Gently open the lid.

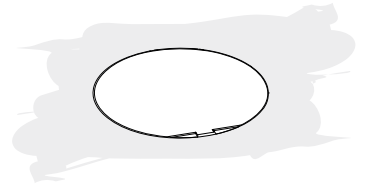

STEP 2

Use the accompanying allen key to loosen the screw holding the fixture in place

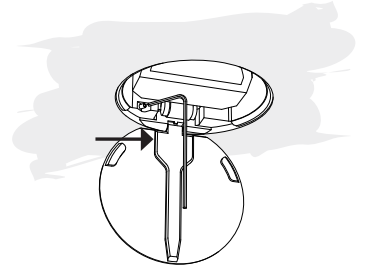

STEP 3

Take hold of the lid and pull down gently, whilst slightly rotating.

NOTE: When rotating the fixture choose the direction with the least resistance.

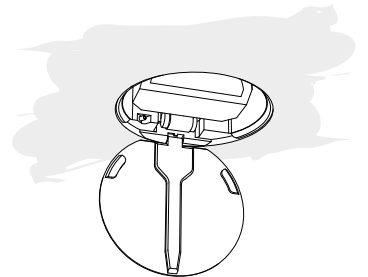

STEP 4

Unscrew the screws, and gently lift the lid off.

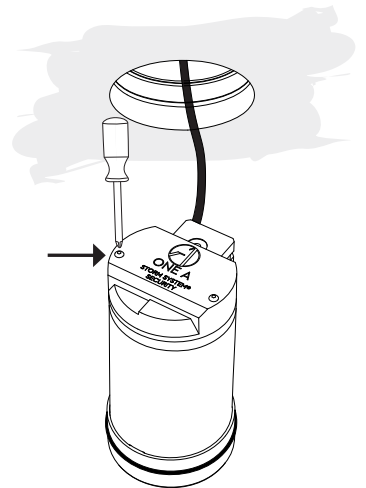

STEP 5

Disconnect the wires

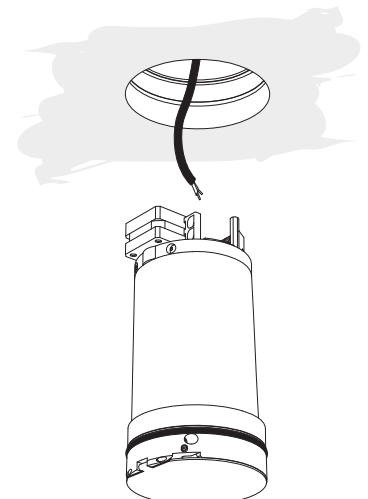

IMPORTANT INFORMATION

Installation and mounting must be performed by a certified electrician only, and instructions must be followed. Always make sure the main power is off during installation. Pay attention to the fixture remarks, and always make sure to use the correct voltage.

CLEANING AND MAINTENANCE:

Use a soft moist cloth for cleaning. No further maintenance is required.

WARRANTY:

If the product is defect, please contact your supplier immediately. Please note that warranty will not apply in case of wrongful use or if unskilled personnel attempts to repair.



The crossed-out wheeled bin symbol indicates that the item should be disposed of separately from household waste. The item should be handed in for recycling in accordance with local environmental regulations for waste disposal

For more information, please contact info@onea.dk

VE1012-D

12m Vector PIR 9C VdS

Aritech, VE1012-D, 12m PIR Wide Angle PIR Motion Detector (9 Curtains)

Motion sensors with advanced mirror optics. This unique optical mirror technology uses a combined step and gliding focussing mirror, which provides the sensor with a continuous detection curtain, which allows detection of an object without interruption. To increase the detection density, sensors of the 1000 series use a "3Brid orthogonal" mirror optic, which generates detection probes with vertical alignment for the detection of IR radiation via a horizontal mirror structure. This orthogonal invention is the key to design a mirror with additional detection curtains without sacrificing signal strength and to increase the size of the sensor.

Key Features:

- Passive infrared motion detector
- 3-Brid Gliding Focus mirror optics
- Sealed optics
- "V2E" Signal evaluation to avoid false alarms
- Detection by coat and umbrella
- Full creep protection
- Autofocus with constant range sensitivity
- No adjustment required for different mounting heights
- Mighty angular deviation of walls
- EN50131-2-2 Grade 2 certified
- Distinctive European approvals applied for VdS recognition: G110516

Technical Specification:

- Detection range : 12m (40ft)
- Anti-creep protection : Yes
- Sensitivity : Normal / High
- Coverage area : 86 ° with 9 curtains
- Mounting height : 1.8 to 3.0 m (6 to 10 ft)
- Power supply : 9 to 15 VDC
- Power consumption (nom.) : 4.4 mA
- Alarm relay (potential-free) : NC when energized
- Sabotage relay (potential-free) : NC when housing is closed
- Alarm memory : No
- PIR signal evaluation : V2E
- Environmental conditions : -10 to + 55 ° C (14 to 130 ° F); 95% relative humidity
- EN50131-2-2 : Grade 2

