

RA Series

RA Suspension

Design by Alexandre Joncas

RA Pendant, modern with simple lines, is suspended by silicon cables at a slight angle. Mounted above a table, its warm light conjures memories of an evening around a campfire.



RA Suspension

Design by Alexandre Joncas

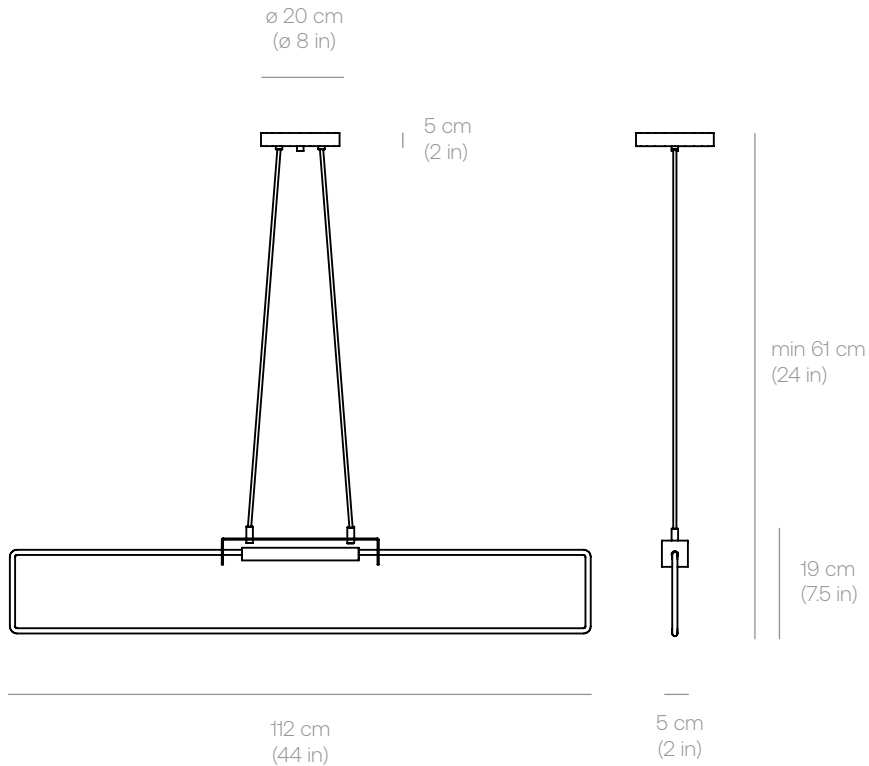

Lamping Specifications

Power input : 45W
 Technology : Cold cathode neon lifetime of 100 000h
 CCT* : 3000K (Warm white)
 Lumen source : 1800 lm
 CRI : 94
 Input voltage : 120V - On/off only
 220-240V - DALI dimming*

* 1-10V and other CCT available upon request.

Product Weight

2.4 kg / 5.2 lbs

Height

A	B	C	D
61 cm (24 in)	89 cm (35 in)	112 cm (44 in)	201 cm (79 in)



*custom height available upon request

Certifications



IP20 

Materials

Canopy & bracket :

-  Glossy White
-  Glossy Black
-  Chrome

Details finishes :

-  Black Oxide
-  Brass
-  Chrome

Order code generator	Serie	Model	Finish	Details	Voltage	Height	QTY
RA	RA	SU	Pendant	WG Glossy White	OX Black Oxide	A 61 cm	.
.	.	.	.	BG Glossy Black	BR Brass	B 89 cm	.
.	.	.	.	CH Chrome	CH Chrome	C 112 cm	.
.	D 201 cm	.
.	Z Custom	.
Order code :	RA	SU	---	---	---	---	---

