

D8



STYLE INDEX	148
MESA	10
ASSEMBLY	14
CYRUS	20
ORBIT	24
VICUNA	28
KIMBELL	30
STACKING	32
GAMES	49
DRAGONFLY	58
FOUNDRY	62
LOOP	64
DAYTON	71
COMPASS	76
AKRON	82
KINK	88
AMES	98
DISTRIKT	101
THEO	112
SALK	124
EXETER	136
KAHN	138
DRIFT	140
FINISHES	144
STYLE INDEX	148
ABOUT	155
CONTACT	156





Left and Right Round Mirror (p. 27), Distrikt Dresser (p. 106), Orbit Armchair (p. 24), Orbit Ottoman (p. 24), Brass Top Shelf (p. 26).



Left and Right Mesa Sofa (p. 10), Distrikt Dresser (p. 106),
Mesa Coffee Table (p. 12), Round Mirror (p. 27).

MESA SOFA

The Mesa Sofas, built in single-, double-, and triple-seater options, are set on a solid oak platform and upholstered with stain-resistant textile. Their slightly tapered shapes offer perfect complementarity to fit along a Mesa Coffee Table.



Dimensions

- a. Mesa 3 seater: L253 W88 H70cm
- b. Mesa 2 seater: L173 W88 H70cm
- c. Mesa 1 seater: L93 W88 H70cm

Standard finishes

Seat / Legs:

- 1. Tweed Sesame / Seared oak
- 2. Tweed Squirrel / Seared oak

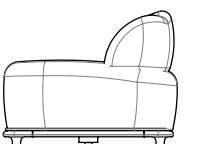
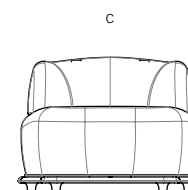
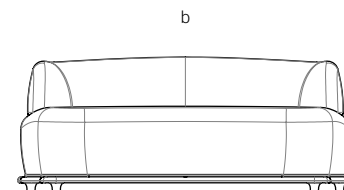
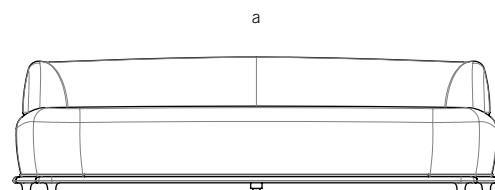
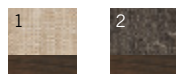

MESA COFFEE TABLE

The Mesa Coffee Table is built on a tapered quadrilateral-shaped solid oak base, which offers various placement possibilities and allows to fit perfectly alongside the Mesa Sofa. It also features a glass top supported by solid oak legs, and brass details.

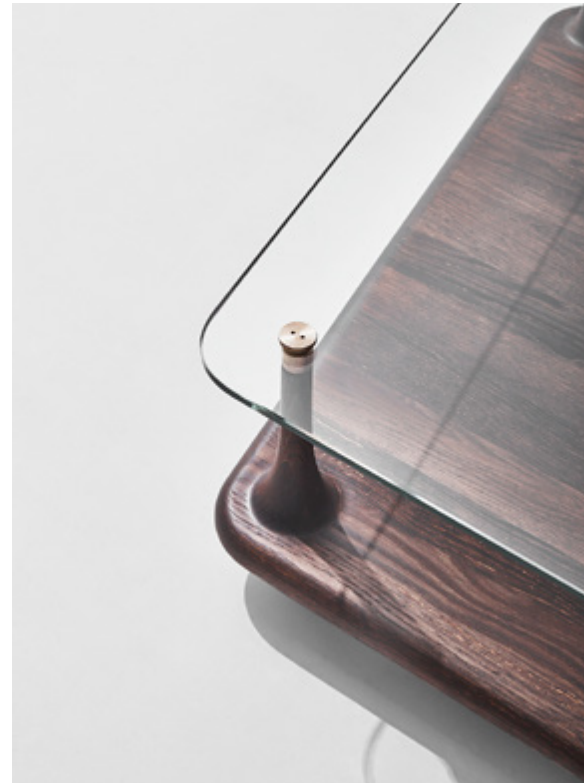

Dimensions / Weight

- a. L93 W84 H29cm
- b. L84 W65 H29cm

Standard finishes

Top / Base + Brass details:

1. Glass / Seared oak
2. Glass / Hard fumed oak

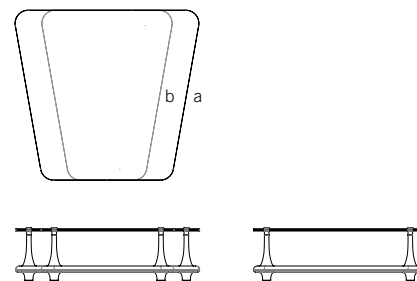

ASSEMBLY TABLE

14

The rectangle Assembly Table features an organically shaped base hand-crafted from solid oak with wood grained cast aluminium. The glass top reveals the joinery and the sculptural structure.



Dimensions

a. L260 W100 H75cm

b. L220 W90 H75cm

Standard finishes

Top / Base + Cast aluminium legs:

1. Glass / Smoked oak
2. Glass / Cerused oak
3. Glass / Hard fumed oak

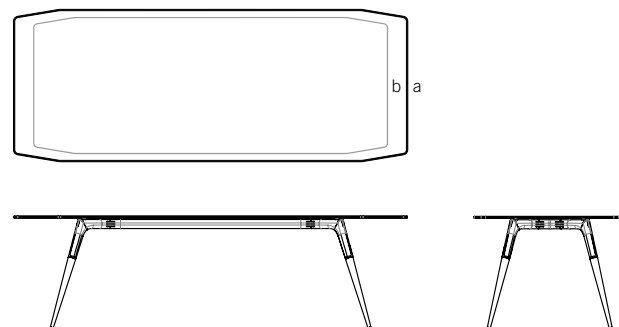

ASSEMBLY TABLE OVAL

15

The oval Assembly Table features a base hand-crafted and shaped from solid oak and wood-grain patterned cast aluminium. The top comes as a piece of glass, revealing the sculptural legs and detailed joinery.



Dimensions

a. L240 W120 H75cm

b. L200 W110 H75cm

Standard finishes

Top / Base + Cast aluminium legs:

1. Oval glass / Smoked oak
2. Oval glass / Cerused oak
3. Oval glass / Hard fumed oak

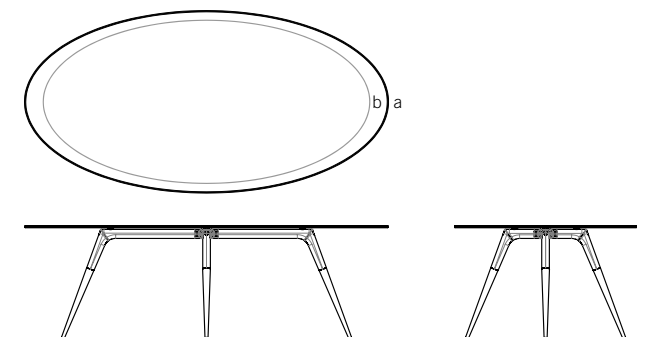

ASSEMBLY BISTRO TABLE

The Assembly Bistro Table features a signature base hand-crafted from solid oak with wood-grained cast aluminium. The glass top sits on brass joinery, revealing the organically sculpted legs.



Dimensions

L100 W100 H75cm

Standard finishes

Top / Base + Cast aluminium legs:

1. Round glass / Smoked oak
2. Round glass / Cerused oak
3. Round glass / Hard fumed oak

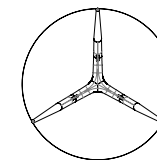

ASSEMBLY DINING CHAIR

The Assembly Dining Chair is built on sculpted oak frames, offering comfortable and durable leather seats, as well as a cast aluminium backrest. They come as a fitting set to our Assembly Tables, or as an original addition to most contemporary spaces.



Dimensions

L54 W53 H82 SH47cm

Standard finishes

Seat / Legs + Aluminium backrest:

- | | |
|---------------------------------------|--------------------------------------|
| 1. Storm leather / Smoked oak | 6. Cordova leather / Hard fumed oak |
| 2. Ink black leather / Smoked oak | 7. Sepia leather / Hard fumed oak |
| 3. Sepia leather / Smoked oak | 8. Ink black leather / Cerused oak |
| 4. Jin leather / Smoked oak | 9. French blue leather / Cerused oak |
| 5. Ink black leather / Hard fumed oak | 10. Cordova leather / Faded oak |
| | 11. French blue leather / Faded oak |

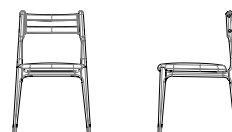

CYRUS SOFA

20

Inspired by an antique cylinder shape, the Cyrus Sofa combines two elements: a hard tube steel frame and a comfortable upholstered seat and backrest. Seat and backrest come in both leather or fabric.



Dimensions

L114 W72 H68 SH43cm

Standard finishes

Seat, backrest + Steel tube frame:

- | | |
|---------------------|------------------------|
| 1. Velvet limestone | 6. Velvet Gold |
| 2. Velvet raffia | 7. French blue leather |
| 3. Velvet petal | 8. Sepia leather |
| 4. Velvet pewter | 9. Ink black leather |
| 5. Velvet rust | 10. Cordova leather |

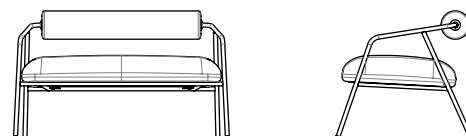

CYRUS CHAIR

21

The Cyrus collection's construction integrates fully two distinct elements. The hard tube steel frame offers a minimal and sharp shape to carry the seat and backrest. Seat and backrest come in both leather or fabric.

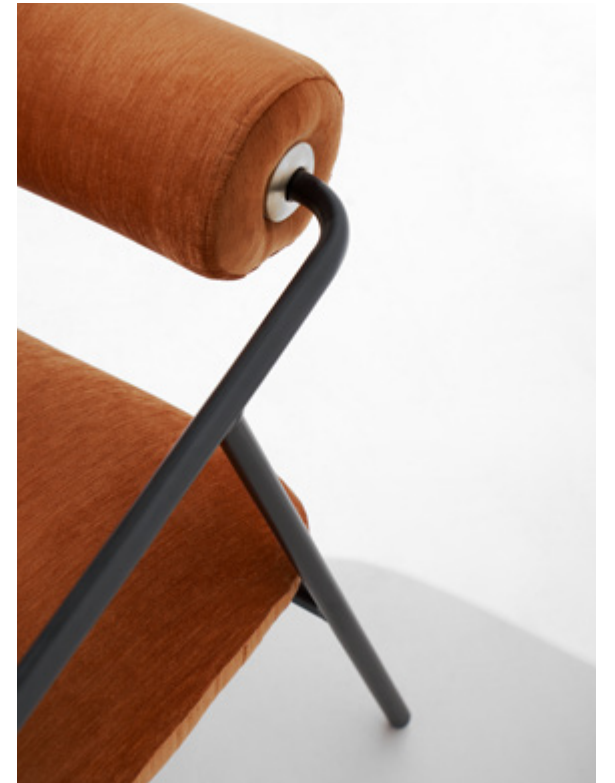

Dimensions

L72 W72 H68 SH43cm

Standard finishes

Seat, backrest + Steel tube frame:

- | | |
|---------------------|------------------------|
| 1. Velvet limestone | 6. Velvet Gold |
| 2. Velvet raffia | 7. French blue leather |
| 3. Velvet petal | 8. Sepia leather |
| 4. Velvet pewter | 9. Ink black leather |
| 5. Velvet rust | 10. Cordova leather |

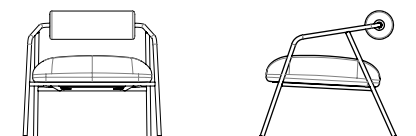



ORBIT ARMCHAIR & OTTOMAN

The Orbit Armchair is built on a circular frame and can swivel 360 degrees on its solid oak base. Made to complement the Orbit Armchair, the Ottoman is built with a rotating oak side table.



Dimensions

a. Orbit Armchair: L87 W85 H72 SH47cm

b. Orbit Ottoman: L72 W65 H41cm

Standard finishes

Cushion / Base:

- | | |
|----------------------------------|-------------------------------|
| 1. Bouclé cream / Seared oak | 6. Velvet petal / Seared oak |
| 2. Bouclé beige / Seared oak | 7. Velvet pewter / Seared oak |
| 3. Bouclé grey / Seared oak | 8. Velvet rust / Seared oak |
| 4. Velvet limestone / Seared oak | 9. Velvet gold / Seared oak |
| 5. Velvet raffia / Seared oak | |

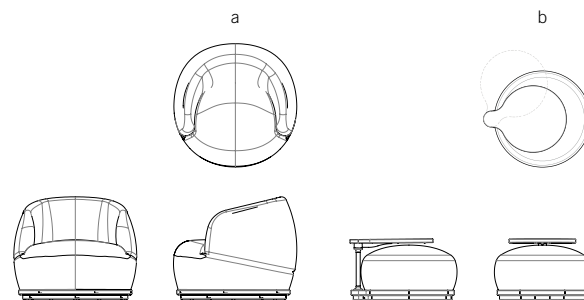
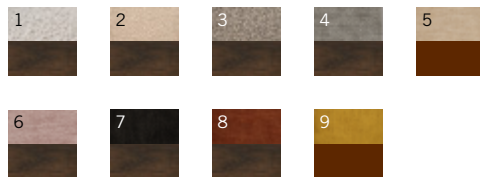

BRASS TOP SHELF

26

A crafty piece of storage, made from smoked glass and patina finished solid brass.

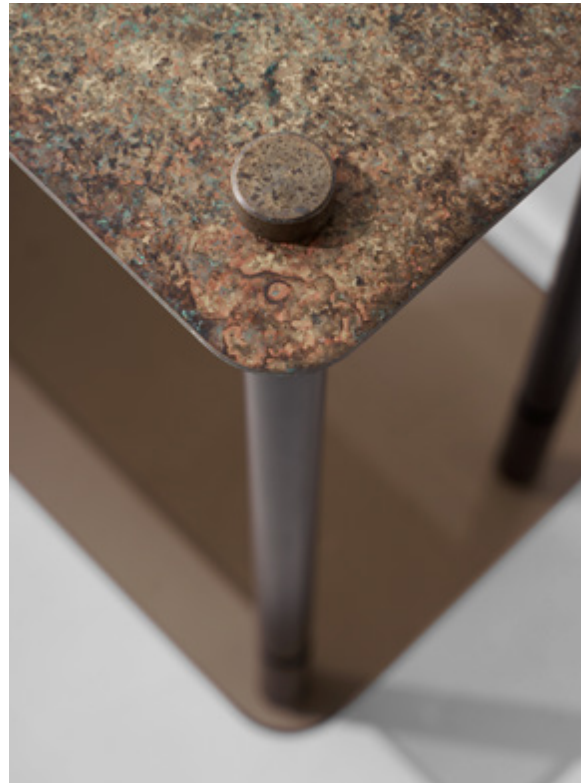

Dimensions

- a. L160 W25 H53cm
- b. L80 W25 H53cm

Standard finishes

Brass patina top shelf / Smoked glass lower shelf
+ Blackened steel tube frame

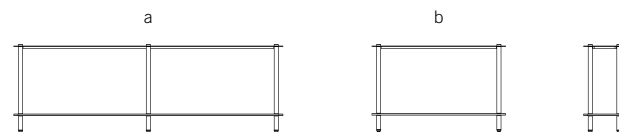

ROUND MIRROR

27

Our mirror is crafted from solid oak. It makes an ideal addition to home or commercial spaces.

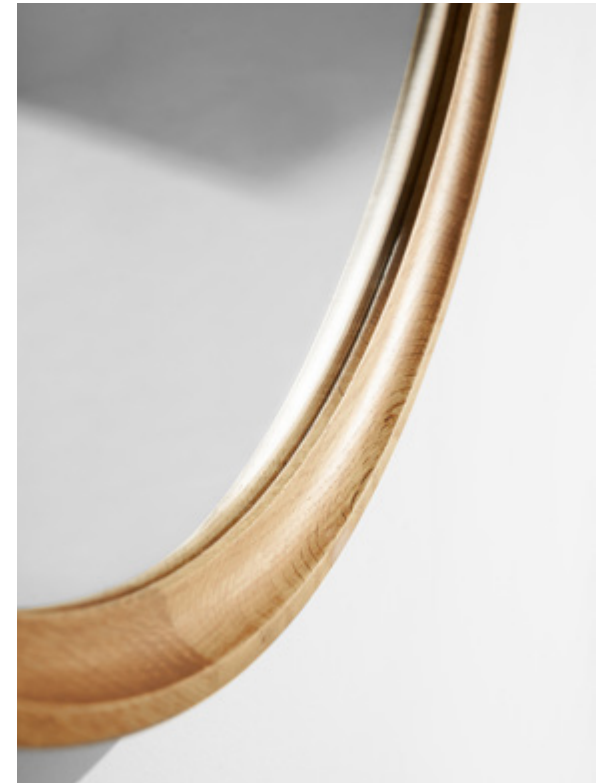

Dimensions

- a. L140 W140 H5cm
- b. L100 W100 H5cm
- c. L60 W60 H5cm

Standard finishes

1. Hard fumed oak / Mirrored glass
2. Smoked oak / Mirrored glass

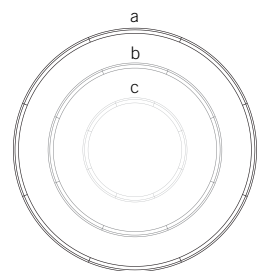

VICUNA DINING CHAIR

28

The Vicuna Dining Chair features a soft body and lean frame with a smoked oak finish, drawing inspiration from its namesake, the wildlife of the high alpine areas of the Andes.



Dimensions

L53 W45 H77 SH47cm

Standard finishes

Seat / Backrest and Legs

1. Bouclé cream / Smoked oak
2. Bouclé beige / Charred black oak
3. Bouclé grey / Charred black oak

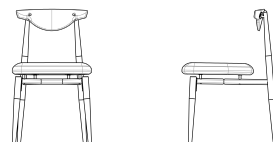

KIMBELL DINING TABLE

Inspired by the architecture of the Kimbell Museum, this table brings a touch of classicism in design, with legs crafted by hand in wood, concrete, steel and brass, supporting a top of solid oak.



Dimensions
L200 W90 H75cm

Standard finishes
Top / Legs + Brass and steel details:
1. Charred black oak / Acid black concrete
2. Smoked oak / Grey concrete

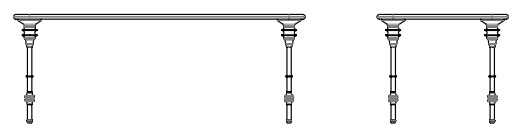
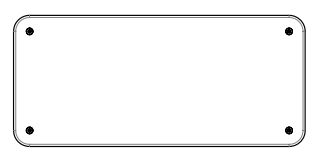

STACKING DROP LEAF TABLE

32

The Stacking Drop Leaf Table is a versatile oak piece designed to quickly transform from a dining table into either a desk, console or a standing shelf by folding down one or both side leaves. By stacking two of our medium benches you have the potential of a whole dining set that conveniently stores against a wall. Crafted from solid oak, blackened steel and highlighted with brass details.



Dimensions

L220 W87 H75cm

Standard finishes

Top + Black steel legs:

1. Hard fumed oak
2. Smoked oak
3. Charred black oak

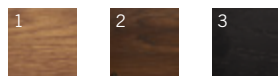
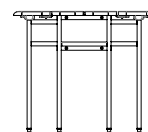
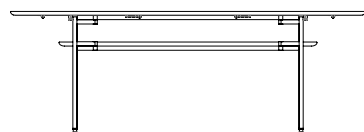
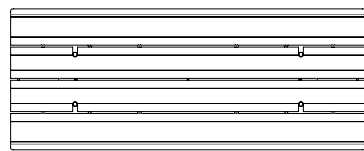



STACKING BENCH

Designed to effortlessly switch from seating to shelving, our unique Stacking Benches create distinct storage options. Crafted from solid oak, blackened steel and highlighted with brass details.



Dimensions

- a. L160 W40 H42 SH42cm
- b. L300 W40 H42 SH42cm

Standard finishes

- Seat + Black steel legs:
1. Hard fumed oak
 2. Smoked oak
 3. Charred black oak

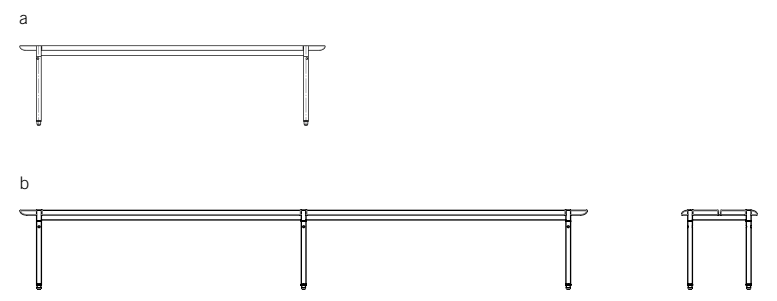
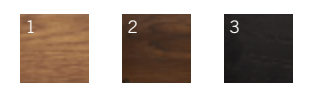

STACKING HIGH CABINET

38

Our unique Stacking Benches create distinct storage options. The High Cabinet is the largest storage function that fits into the stacking system, including two rows of drawers lined with moleskin. Our cabinets are crafted from solid oak, blackened steel and highlighted with brass details.



Seen here with Stacking Low Cabinet (p. 41)

Dimensions

- a. L160 W50 H75cm
- b. L298 W50 H75cm

Standard finishes

Body + Black steel legs:

1. Hard fumed oak
2. Smoked oak
3. Charred black oak

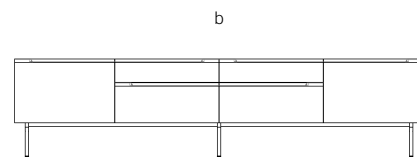
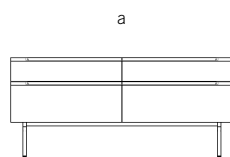
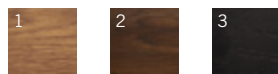

STACKING MID CABINET

40

The Mid Cabinet is a valuable storage option that fits into the stacking system, including drawers lined with moleskin. Our cabinets are crafted from solid oak, blackened steel and highlighted with brass details.



Seen here with Stacking Bench (p. 37)

Dimensions

- a. L298 W50 H48cm
- b. L160 W50 H48cm

Standard finishes

Body + Black steel legs:

1. Hard fumed oak
2. Smoked oak
3. Charred black oak

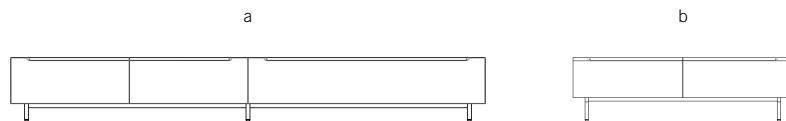
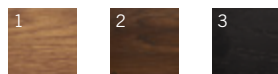

STACKING LOW CABINET

41

The Low Cabinet is a compact storage option that fits well in smaller volumes, featuring slim drawers lined with moleskin. Our cabinets are crafted from solid oak, blackened steel and highlighted with brass details.



Dimensions

- a. L298 W50 H30cm
- b. L160 W50 H30cm

Standard finishes

Seat + Black steel legs:

1. Hard fumed oak
2. Smoked oak
3. Charred black oak

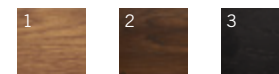







Left and Right Shuffleboard Table Small (p. 52).

FOOSBALL TABLE

Our signature Foosball Table is designed and engineered to the finest detail. Every component is crafted, combining cast iron, oak and concrete, with unique details such as the player's hats. The Foosball Table has already been a statement piece within the most inspiring spaces worldwide.

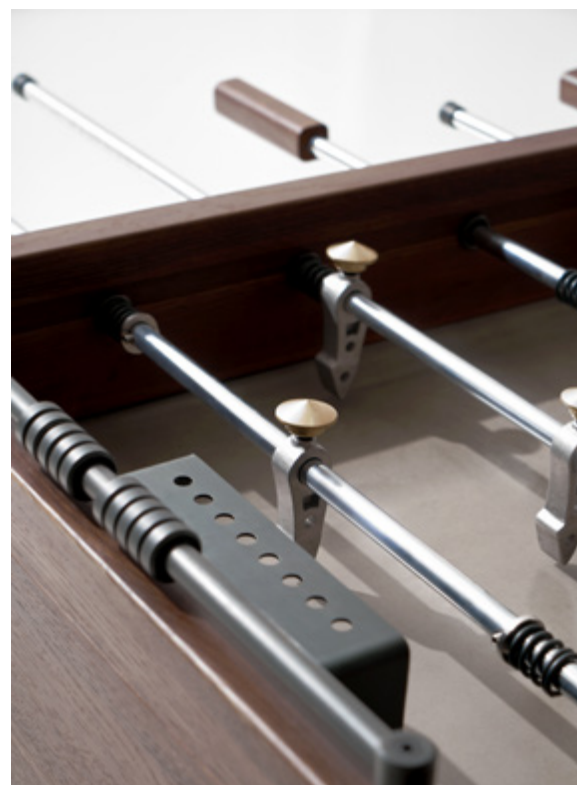

Dimensions

L154 W190 H95cm

Standard finishes

Top / Frame + Cast iron base:
Grey concrete / Smoked oak

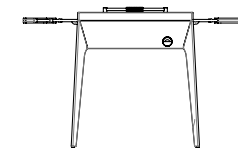
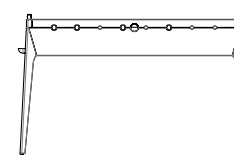
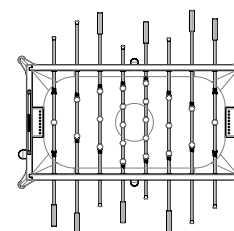

PING-PONG TABLE

Our signature Ping-Pong Table is both interactive and functional. It will seamlessly convert a space into a leisure or work space by shifting from a game table to a meeting or dining table.



Dimensions

L274 W178 H93cm

Standard finishes

Top / Net + Cast iron legs:
Smoked oak / Jin leather

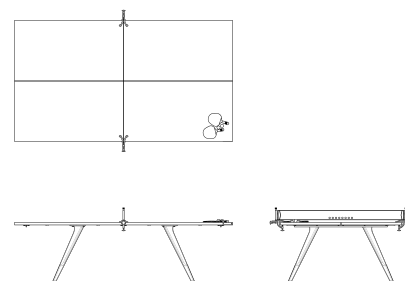

SHUFFLEBOARD TABLE

52

Our Shuffleboard Table is built from smoked oak, with a hand stitched leather landing surface and a game board of laminated solid oak that is finished with a high durability lacquer. The solid cast iron base features adjustable feet for level play.



Dimensions

a. L396 W74 H80cm
b. L275 W74 H80cm

Standard finishes

Top / Frame + Cast iron base:
Jin leather & Raw oak top / Smoked oak

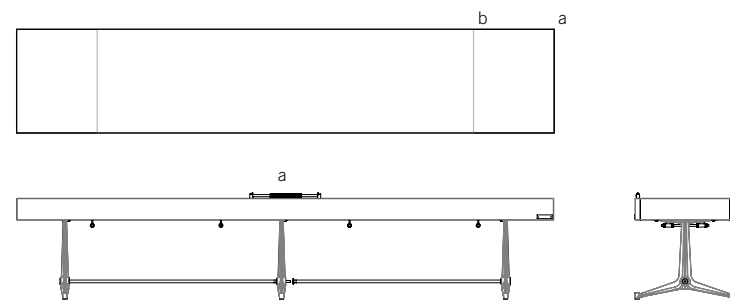
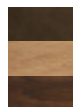

POKER TABLE

53

The newest addition to our games collection, the Poker Table features a smoked oak top and a crafted leather edge. The base is made with a complete solid cast iron finish.



Seen here with Assembly Dining Chair (pg.18).

Dimensions

L160 W160 H77cm

Standard finishes

Top / Frame + Felt top center, Cast iron base:
Jin leather / Smoked oak

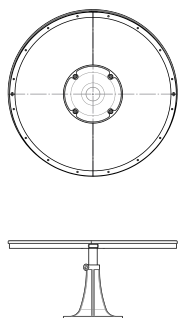





Left Foundry Table A (p. 62), Assembly Dining Chair (p. 14)
Right Loop Dining Chair (p. 64), Stacking Bench (p. 37).

DRAGONFLY DINING CHAIR

58

The Dragonfly Dining Chair features a thin and enveloping backrest. Its frame is built with a black steel tube, while the seat comes in either a leather or fabric finish.



Dimensions

L63 W56 H79 SH48cm

Standard finishes

Seat + Black steel legs:

1. French blue leather
2. Ink black leather
3. Squirrel tweed fabric
4. Sesame tweed fabric

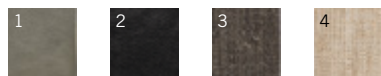

DRAGONFLY LOUNGE CHAIR

60

The Dragonfly Lounge Chair emphasizes its distinct shape with a strong, sharp, and wide backrest. Its frame is built with a black steel tube, while the seat comes in either a leather or fabric finish.



Dimensions

L74.5 W66 H74.5 SH47cm

Standard finishes

Seat + Black steel tube legs:

1. Ink black leather
2. French blue leather



FOUNDRY TABLE A

62

The Foundry Table A features a solid oak base with two configurations based upon your preferred chair width. The tabletop is available in either solid oak or two choices of marble.



Dimensions

- a. L260 W100 H75cm
- b. L220 W100 H75cm
- c. L180 W90 H75cm

Standard finishes

Top / Legs:

- 1. Nero marble / Black cerused
- 2. Seared oak / Seared oak
- 3. White marble / Faded oak
- 4. Faded oak / Faded oak

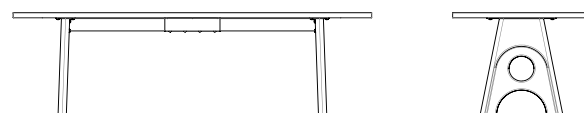

FOUNDRY TABLE T

63

The Foundry Table T features an oak base with three configurations based upon your preferred chair width. Each leg is also hollowed to facilitate wiring if used as a meeting table or desk. The tabletop is available in either solid oak or two choices of marble.



Dimensions

- a. L260 W100 H75cm
- b. L220 W100 H75cm
- c. L180 W90 H75cm

Standard finishes

Top / Legs:

- 1. Nero marble / Black cerused
- 2. Seared oak / Seared oak
- 3. White marble / Faded oak
- 4. Faded oak / Faded oak

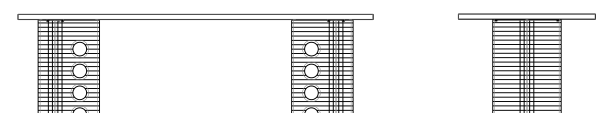
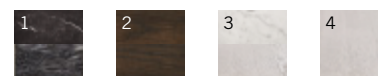

LOOP DINING CHAIR

64

A unique contemporary design, the fabric upholstered Loop Dining Chair has a conveniently placed leather loop handle to slide the chair up to the table. The Loop collection focuses on ergonomics and comfort for post-modernist spaces.



Dimensions

L60 W58 H75.5 SH51cm

Standard finishes

Seat / Strap + Blackened steel legs:

1. Velvet limestone / French blue leather
2. Velvet raffia / Sepia leather
3. Velvet pewter / Ink black leather
4. Velvet gold / Mustard leather

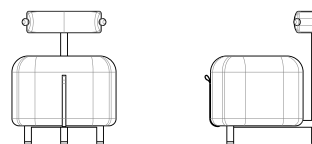
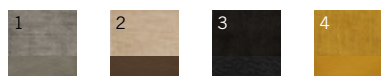

LOOP BANQUETTE

65

The two-seater upholstered Loop Banquette has a conveniently placed pair of leather loop handles to slide the seating up to the table. The Loop collection focuses on ergonomics and comfort for post-modernist spaces.



Dimensions

L116 W58 H75.5 SH51cm

Standard finishes

Seat / Strap + Blackened steel legs:

1. Velvet limestone / French blue leather
2. Velvet raffia / Sepia leather
3. Velvet pewter / Ink black leather
4. Velvet gold / Mustard leather

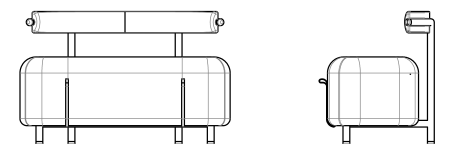





Left Kink Dining Chair (p. 88), Compass Dining Table (p. 78), Stacking High Cabinet (p. 38); **Right** Compass Desk (p. 78).



DAYTON COUNTER STOOL

The Dayton stool collection is crafted from natural materials. The backrest and seat are made of solid oak, a leather cushion and a tube steel frame with brass features to complete the design.



Dimensions

L57 W55 H93 SH65cm

Standard finishes

Seat / Backrest + Black steel tube frame:

1. Storm leather / Charred black oak
2. Umber leather / Hard fumed oak
3. Jin leather / Smoked oak

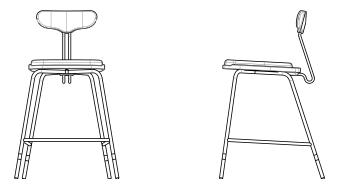
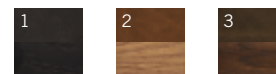

DAYTON BAR STOOL

72

The Dayton Bar Stool is a variation offering a taller seat height than the Counter Stool. The backrest and seat are made of solid oak, a leather cushion and a tube steel frame with brass features complete the design.



Dimensions

L57 W57 H102 SH75cm

Standard finishes

Seat / Backrest + Black steel tube frame:

1. Storm leather / Charred black oak
2. Umber leather / Hard fumed oak
3. Jin leather / Smoked oak

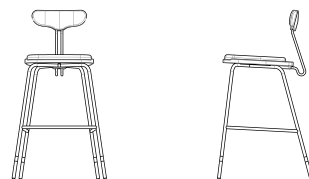
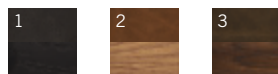

DAYTON DINING CHAIR

74

The Dayton Dining Chair is crafted from natural materials. Backrest and seat in solid oak, leather cushion and tube steel frame with brass features to complete the design.



Dimensions

L53 W52 H77 SH48cm

Standard finishes

Seat / Backrest + Cast iron base:

1. Storm leather / Charred black oak
2. Umber leather / Hard furmed oak
3. Jin leather / Smoked oak

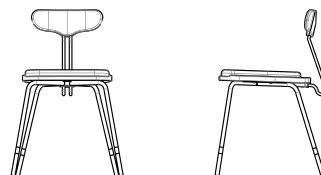
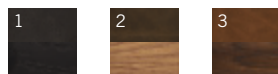

DAYTON LOW STOOL

75

The Dayton Low Stool is a compact piece for all multi-function spaces. The seat is made of solid oak, a leather cushion and a tube steel frame with brass features completes the design.



Dimensions

L50 W47 H48 SH48cm

Standard finishes

Seat + Cast iron base:

1. Storm leather
2. Umber leather
3. Jin leather

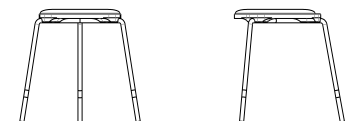
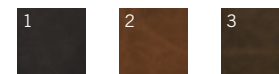

COMPASS DINING TABLE

76

The Compass Dining Table features a base crafted from cast iron with our signature blackened finish and a shape inspired by industrial design and methodology. The solid oak top is worked in smoked finish.



Dimensions

- a. L280 W120 H75cm
- b. L240 W120 H75cm
- c. L200 W100 H75cm
- d. L160 W90 H75cm

Standard finishes

Smoked oak top + Cast iron base and legs

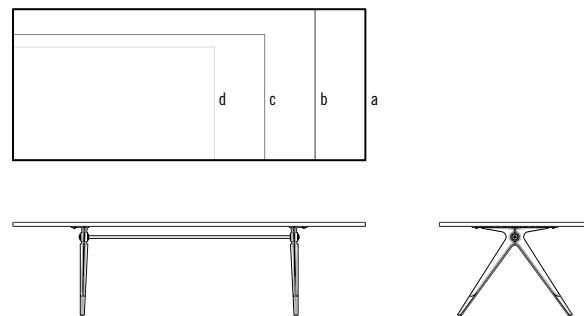

COMPASS STANDING BAR

77

Inspired by original industrial design, the Compass Standing Bar has been created to show a modern interpretation. The base and post are made of black steel, featuring brass and a hand-welded collar. Finished with solid oak top.



Dimensions

- Table top L65 W65 H3.2cm
- Overall L72.5 W70.1 H115cm

Standard finishes

Smoked oak top + Cast iron base and legs

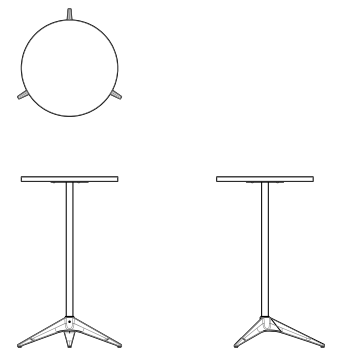

COMPASS DESK

The Compass Desk is a contemporary take on industrial design, featuring brushed brass collars set into our signature cast iron legs. The clean line top is handcrafted entirely from solid oak.



Dimensions

a. Double Drawer: L180 W90 H74cm

b. Single Drawer: L140 W70 H74cm

Standard finishes

Top + Cast iron base:

1. Smoked oak
2. Hard fumed oak

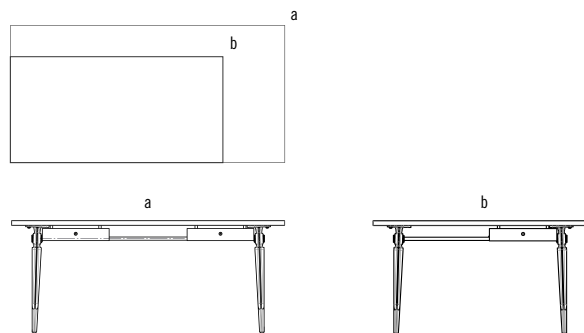

COMPASS BISTRO TABLE SQUARE

80

Inspired by original industrial design, the Compass Bistro Table has been created as a contemporary interpretation. The base and post are made of black steel, featuring brass and a hand-welded collar. Finished with solid oak top.



Base can be sold separately

Dimensions

a. L100 W100 H74cm
b. L80 W80 H74cm

Standard finishes

Smoked oak top + Cast iron base

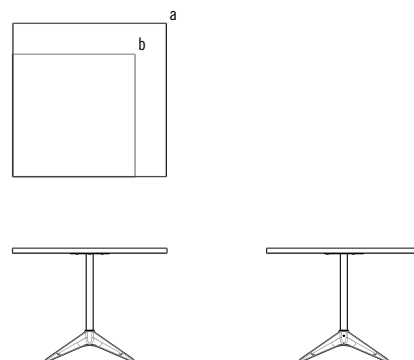

COMPASS BISTRO TABLE CIRCULAR

81

The Circular Bistro Table is a variant offering a convivial alternative, reminiscent of European cafe terraces. The base and post are made of black steel, featuring brass and a hand-welded collar. Finished with solid oak top.



Base can be sold separately

Dimensions

a. L100 W100 H74cm
b. L80 W80 H74cm

Standard finishes

Smoked oak top + Cast iron base

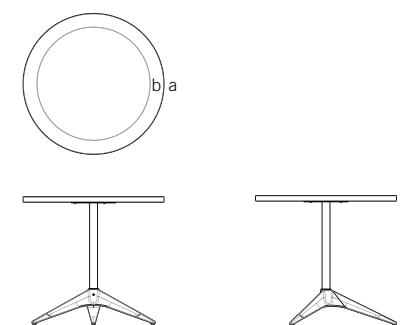

AKRON DINING CHAIR

82

The Akron Dining Chair features a subtly curved backrest, leather seat and a bent steel frame connected with brazed cast iron. Backrest comes in oak or leather.



Dimensions

L60 W60 H72 SH46cm

Standard finishes

Seat / Oak backrest + Cast iron base:

1. Jin leather / Smoked oak
2. Storm leather / Charred black oak
3. Umber leather / Hard fumed oak

Seat / Solf backrest + Cast iron base

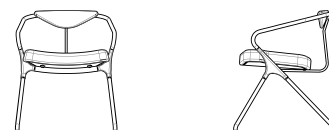
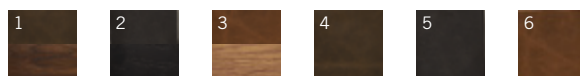

AKRON COUNTER STOOL (WITH BACKREST)

83

Incorporating a backrest into this contemporary iteration of the industrial task stools, the Akron stools feature solid oak backrest, brass detailing and hand-stitched leather seats with a frame of cast iron and tube steel.

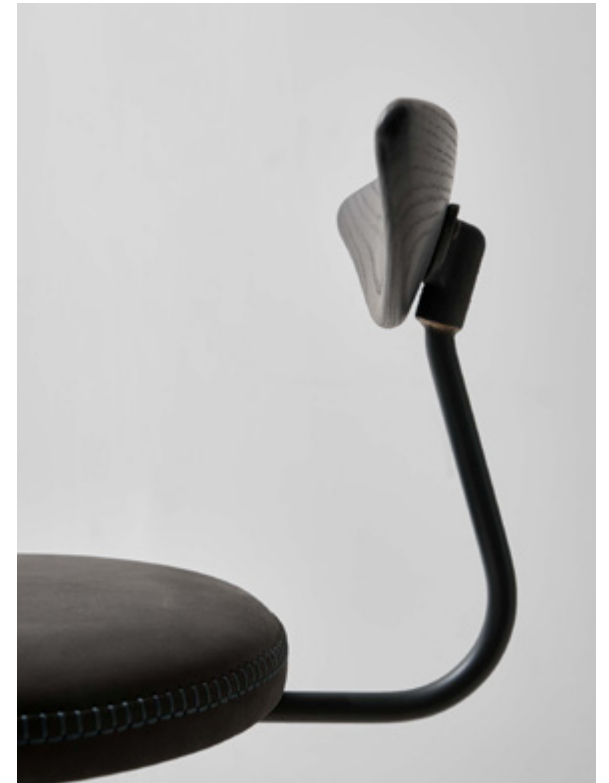

Dimensions

L58 W58 H91-103 SH66-78cm

Standard finishes

Seat / Backrest + Cast iron base and legs:

1. Storm leather / Charred black oak
2. Jin leather / Smoked oak
3. Umber leather / Hard fumed oak

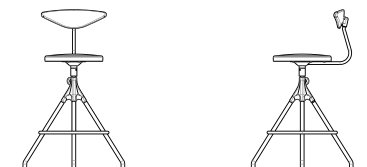
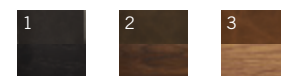

AKRON LOW STOOL (WITH LEATHER SEAT)

84

Designed with a contemporary iteration of the industrial task stools in mind, the Akron stools feature brass detailing and hand stitched leather seats with a frame of cast iron and tube steel.



Dimensions

L39 W42 H50 SH50cm

Standard finishes

Seat + Cast iron base and legs:

1. Jin leather seat
2. Storm leather seat
3. Umber leather seat

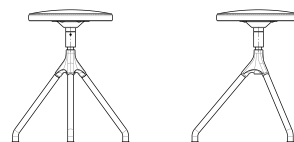

AKRON COUNTER STOOL

85

The Akron Counter stool is a higher seating option, featuring brass detailing and hand stitched leather seats with a frame of cast iron and tube steel.



Dimensions

L58 W59 H67-79cm

Standard finishes

Seat + Cast iron base and legs:

1. Jin leather seat
2. Storm leather seat
3. Umber leather seat

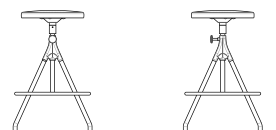

AKRON BAR STOOL (WITH BACKREST)

86

Incorporating back and armrests into this contemporary iteration of the industrial task stools, the Akron stools feature solid oak backrest, brass detailing and hand stitched leather seats with a frame of cast iron and tube steel.



Dimensions

L68 W68 H100 SH75cm

Standard finishes

Seat / Backrest + Cast iron base and legs:

1. Storm leather / Charred black oak
2. Umber leather / Hard furmed oak
3. Jin leather / Smoked oak

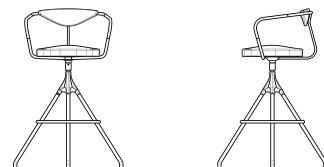
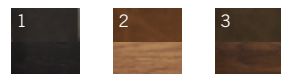

AKRON DESK CHAIR

87

The Akron Desk Chair features a gently curved backrest, brass details and a hand stitched leather seat with a frame of cast iron and tube steel. Height is adjustable.



See Akron Dining Chair p.82 for Soft backrest detail

Dimensions

L73 W73 H75-84 SH46-55cm

Standard finishes

Seat / Oak backrest + Cast iron base

1. Storm leather / Charred black oak
2. Jin leather / Smoked oak
3. Umber leather / Hard furmed oak

Seat / Soft backrest + Cast iron base



KINK DINING CHAIR

88

The Kink Dining Chair shows a unique aesthetic in chair design, modernizing industrial materials with its curved composite / veneer backrest, solid oak seat and steel frame with brass features. Seat options include solid oak and leather.



Dimensions

- a. Without cushion L68 W60 H75 SH41cm
- b. With cushion L68 W60 H75 SH44cm

Standard finishes

a. Seat, Backrest + Black tube steel frame:

- a.1. Smoked oak
- a.2. Hard fumed oak
- a.3. Charred black oak

b. Cushion / Seat, Backrest + Black tube steel frame:

- b.1. Jin leather / Smoked oak
- b.2. Umber leather / Hard fumed oak
- b.3. Storm leather / Charred black oak

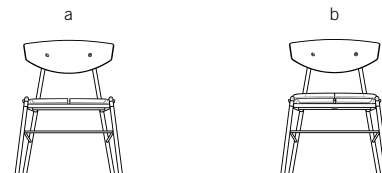
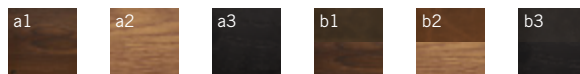

KINK LOUNGE CHAIR

89

The Kink Lounge Chair reactualizes industrial materials through contemporary design, with its curved composite / veneer backrest, solid oak seat and steel frame with brass features. Seat options include solid oak, fabric and leather.



Dimensions

- L71 W63 H74 SH38cm

Standard finishes

Cushion / Seat, Backrest + Black tube steel frame:

- 1. Jin leather / Smoked oak
- 2. Umber leather / Hard fumed oak
- 3. Storm leather / Charred black oak

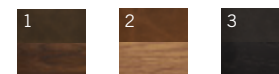

KINK BAR STOOL

90

The Kink Bar Stool reinterprets industrial references into a contemporary shape, with its curved composite/veneer backrest, solid oak seat and steel frame with brass features. Seat options include solid oak, fabric and leather.



Dimensions

- a. Without cushion L64 W51 H101 SH69cm
- b. With cushion L64 W51 H101 SH72cm

Standard finishes

a. Seat, Backrest + Black tube steel frame:

- a.1. Smoked oak
- a.2. Hard fumed oak
- a.3. Charred black oak

b. Cushion / Seat, Backrest + Black tube steel frame:

- b.1. Jin leather / Smoked oak
- b.2. Umber leather / Hard fumed oak
- b.3. Storm leather / Charred black oak

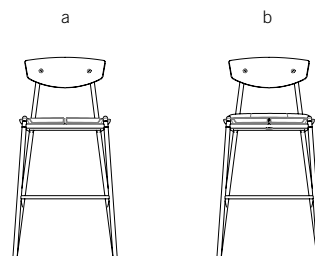
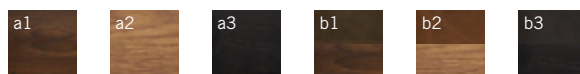

KINK COUNTER STOOL

91

The Kink Counter Stool is a lower seating option in height, reinterpreting industrial references into a contemporary shape, with its curved composite/veneer backrest, solid oak seat and steel frame with brass features. Seat options include solid oak, fabric and leather.



Dimensions

- a. Without cushion L61 W52 H92 SH59cm
- b. With cushion L61 W52 H92 SH62cm

Standard finishes

a. Seat, Backrest + Black tube steel frame:

- a.1. Smoked oak
- a.2. Hard fumed oak
- a.3. Charred black oak

b. Cushion / Seat, Backrest + Black tube steel frame:

- b.1. Jin leather / Smoked oak
- b.2. Umber leather / Hard fumed oak
- b.3. Storm leather / Charred black oak

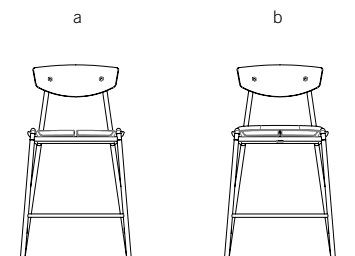





Left and Right Theo Wall Unit Clothing Rail with Drawer (p. 114), Theo Wall Unit with Cabinet (p. 114), Theo Wall Unit with Medium Shelves (p. 115), Distrikt Armchair (p. 102)



Left Distrikt Trolley (p. 108), Stacking High Cabinet (p. 38),
Right Distrikt Bed (p. 109).

AMES DINING CHAIR

Designed with inspiration from the shape of a spade, the Ames chair features a smoked oak frame and a premium fabric cushion, designed to offer comfort while retaining our signature modern industrial finish.



Dimensions

a. Dining chair	L54	W63	H86	SH46cm
b. Low dining chair	L54	W63	H80	SH40cm

Standard finishes

Front / Back / Legs:

1. Gema lotus / Arda lotus / Smoked oak
2. Gema cola / Arda cola / Smoked oak
3. Gema monsoon / Arda monsoon / Smoked oak
4. Gema pearl / Arda pearl / Smoked oak
5. Gema caviar / Arda caviar / Smoked oak

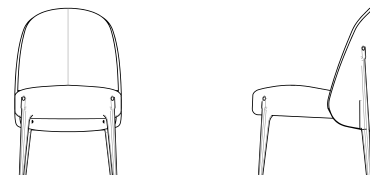

DISTRIKT CHAISE

With a modernist aesthetic, the Distrikt Chaise is crafted from solid oak, steel legs and with African padouk joinery as a feature.



Dimensions

L220 W85 H81 SH46cm

Standard finishes

Cushion / Base + Steel legs:

- 1. Diego nuance / Hard fumed oak
- 2. Diego melba / Hard fumed oak
- 3. Diego nuance / Smoked oak
- 4. Diego nehru / Smoked oak
- 5. Diego nuance / Faded oak

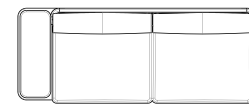

with left tray

with right tray

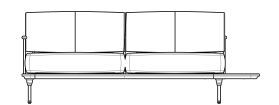
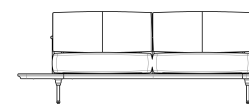

DISTRIKT ARMCHAIR

102

With a modernist aesthetic, the Distrikt Armchair is crafted from solid oak, steel legs and with African padouk joinery as a feature.



Dimensions

L86 W82 H81 SH46cm

Standard finishes

Cushion / Base + Steel legs:

1. Diego nuance / Hard fumed oak
2. Diego melba / Hard fumed oak
3. Diego nuance / Smoked oak
4. Diego nehru / Smoked oak
5. Diego nuance / Faded oak

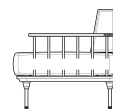
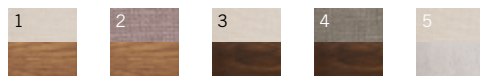

DISTRIKT OTTOMAN

104

An addition to the Distrikt Sofa collection, the Ottoman is crafted from solid oak, steel legs.



Dimensions

L86 W83 H47 SH47cm

Standard finishes

Cushion / Base + Steel legs:

1. Diego nuance / Hard fumed oak
2. Diego melba / Hard fumed oak
3. Diego nuance / Smoked oak
4. Diego nehru / Smoked oak
5. Diego nuance / Faded oak

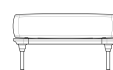

DISTRIKT COFFEE TABLE

105

The Distrikt Coffee Table is crafted from solid oak and veneer oak, steel and brass. It features a hidden storage compartment. A very modernist piece combining transatlantic inspirations, part of the Distrikt collection.



Dimensions

L120 W70 H39cm

Standard finishes

Top + Steel legs:

1. Hard fumed oak
2. Smoked oak

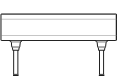

DISTRIKT DRESSER

106

Designed to meet a range of storage needs, the Distrikt Dresser offers deep drawers with easy to use metal glides. Made from solid oak with solid steel legs and brass glides to finish.



Dimensions

L170 W48 H83cm

Standard finishes

Body + Tube steel frame:

1. Hard fumed oak
2. Smoked oak

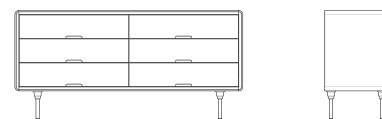

DISTRIKT TALLBOY

107

Designed as an addition to the Distrikt bed, this tallboy incorporates a hidden mirror and a make up / jewellery box.



Dimensions

L75 W48 H135-174cm (mirror close-open)

Standard finishes

Body + Mirror inside and steel legs:

1. Hard fumed oak
2. Smoked oak

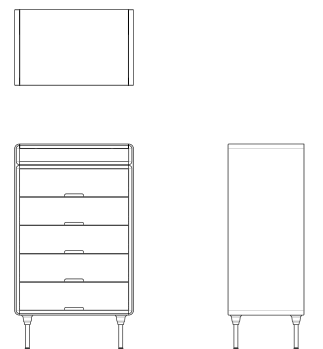

DISTRIKT TROLLEY

108

An ideal piece for entertaining or for storing barware and spirits, this hand crafted piece is a unique modernist addition to all tasteful spaces.



Dimensions

L72 W45 H78cm

Standard finishes

Body + Steel frame:

1. Hard fumed oak
2. Smoked oak

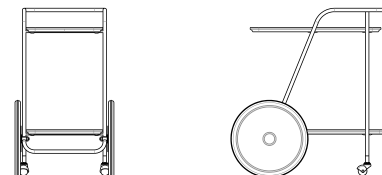

DISTRIKT BED

109

The modernist Distrikt Bed features a platform with incorporated side tables. Solid oak construction with padouk joinery details. Legs of solid steel and levelling brass glides.



Dimensions

- | | |
|----------------------------------|-------------------|
| a. King mattress north american | - L229 W279 H86cm |
| b. Queen mattress north american | - L229 W239 H86cm |
| c. King mattress standard | - L229 W269 H86cm |
| d. Queen mattress standard | - L225 W246 H86cm |
| e. King mattress asia | - L225 W280 H86cm |
| f. Queen mattress asia | - L225 W256 H86cm |
| g. King mattress taiwan | - L215 W269 H86cm |
| h. Queen mattress taiwan | - L215 W238 H86cm |

Standard finishes

Frame and backhead + Steel legs:

1. Hard fumed oak
2. Smoked oak

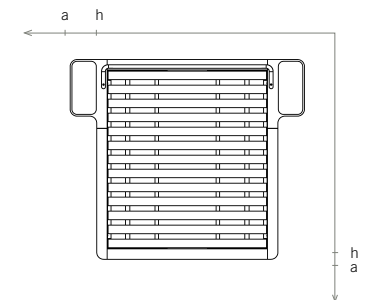

DISTRIKT CANOPY BED

The original Distrikt platform bed incorporates side tables and is updated to include a steel canopy detailed with brass. Solid oak construction with legs of steel and levelling brass glides.



Dimensions

- a. King mattress north american - L229 W279 H207cm
- b. Queen mattress north american - L229 W239 H207cm
- c. King mattress standard - L229 W269 H207cm
- d. Queen mattress standard - L225 W246 H207cm
- e. King mattress asia - L225 W280 H207cm
- f. Queen mattress asia - L225 W256 H207cm
- g. King mattress taiwan - L215 W269 H207cm
- h. Queen mattress taiwan - L215 W238 H207cm

Standard finishes

Frame and backhead + Steel legs:

1. Hard fumed oak
2. Smoked oak

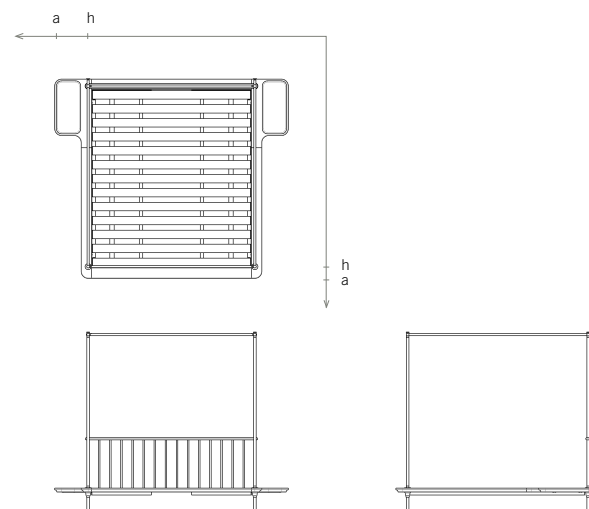

THEO TRACTOR COUNTER STOOL

112

The Theo Tractor Counter Stool offers a solid surface seat, and features our signature solid oak Theo legs and steel stretchers. The shell design is inspired by the industrial tractor seat of the early 20th century.



Dimensions

L52 W48 H65 SH58cm

Standard finishes

Seat / Leg + Brass plate steel:

1. Solid surface in black / Charred black oak
2. Solid surface in white / Hard fumed oak
3. Solid surface in white / Smoked oak

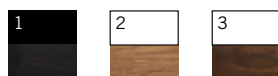

THEO TRACTOR BAR STOOL

113

The Theo Tractor Bar Stool comes as a higher seating option to the Counter Stool. It offers a solid surface seat, and features our signature solid oak Theo legs and tube steel foot support. The shell design is inspired by the industrial tractor seat of the early 20th century.



Dimensions

L54 W49 H80 SH74cm

Standard finishes

Seat / Leg + Brass plate steel:

1. Solid surface in black / Charred black oak
2. Solid surface in white / Hard fumed oak
3. Solid surface in white / Smoked oak



THEO WALL UNIT

The Theo Wall Units feature solid oak panels that allow for versatility and multiple storage options within home & office. The styles available also offer soft-edged configurations with a desk, cabinet, or bar counter.



Dimensions

- a.Theo Wall Unit Clothing Rail L124 W31 H211cm
- b.Theo Wall Unit with Cabinet L124 W47 H211cm
- c.Theo Wall Unit with Bar L83 W47 H211cm

Instruction

Each Theo Wall Unit is delivered by default with only 1 capping post. When purchasing a first Theo Wall unit, make it a stand alone unit by purchasing 1 extra capping post. To extend a stand alone unit, purchase another Theo Wall Unit, as you only need 1 capping post.

Standard finishes

Body + Steel bracing:

1. Charred black oak
2. Hard fumed oak
3. Smoked oak

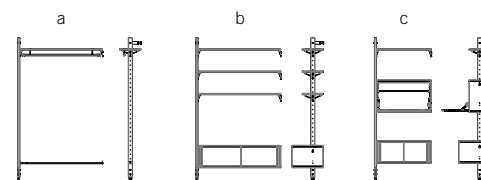
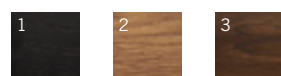

Dimensions

- d. Theo Wall Unit Clothing Rail with Drawer L124 W46 H211cm
- e. Theo Wall Unit with Desk L124 W47 H211cm
- f. Theo Wall Unit with Large Shelves L124 W31 H211cm
- g. Theo Wall Unit with Medium Shelves L84 W31 H211cm

Instruction

Each Theo Wall Unit is delivered by default with only 1 capping post. When purchasing a first Theo Wall unit, make it a stand alone unit by purchasing 1 extra capping post. To extend a stand alone unit, purchase another Theo Wall Unit, as you only need 1 capping post.

Standard finishes

Body + Steel bracing:

1. Charred black oak
2. Hard fumed oak
3. Smoked oak

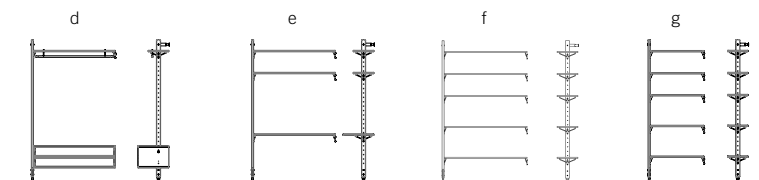
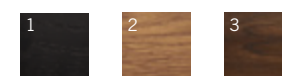

HALLWAY MIRROR

116

Our Hallway Mirror is crafted from solid oak. It provides an elegant addition to home or commercial spaces.



Dimensions

L180 W40 H5cm

Standard finishes

Frame + Mirror glass:

1. Hard fumed oak
2. Smoked oak



HALF CIRCLE MIRROR

117

Our Half Circle Mirror is crafted from solid oak, and brings an edge to contemporary and modernist interiors.



Dimensions

L180 W90 H5cm

Standard finishes

Frame + Mirror glass:

1. Hard fumed oak
2. Smoked oak

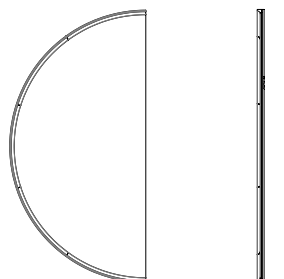

FLOOR MIRROR

118

Our Floor Mirror is designed with a slight tapered shape, crafted from solid oak, making it a functional and elegant feature to any foyer or bedroom.



Dimensions

L200 W65 H4cm

Standard finishes

Frame + Mirror glass:

1. Hard fumed oak
2. Smoked oak

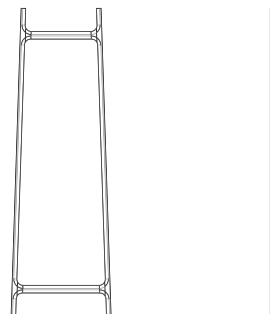





SALK DINING TABLE

124

The Salk Dining Table is built on the collection's signature concrete legs. The tapered legs combine with a solid oak top, expressing contemporary craft.



Dimensions

- a. L140 W140 H75cm
- b. L140 W80 H75cm
- c. L160 W80 H75cm

Standard finishes

Top / Legs:

1. Charred black oak / Acid black concrete
2. Seared oak / Grey concrete
3. Raw oak / Grey concrete

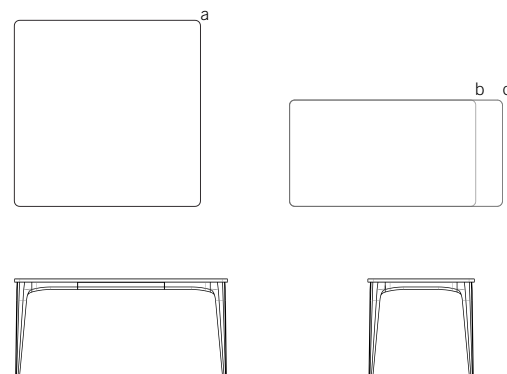
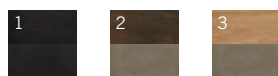

SALK EXPANDING DINING TABLE

125

The Salk Expanding Dining Table is crafted from a solid oak table top and sculpted concrete legs. Concealed in the top is an extension mechanism easily managed by a single person to take the table from a 6 to an 8 seater.



Dimensions

- Min: L200 W100 H75cm
- Max: L240 W100 H75cm

Standard finishes

Top / Legs:

1. Charred black oak / Acid black concrete
2. Seared oak / Grey concrete
3. Raw oak / Grey concrete

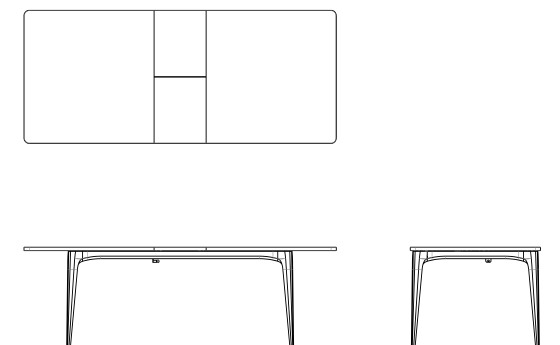
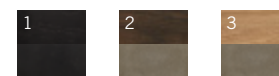

SALK COFFEE TABLE

126

The Salk Coffee Table is designed for large spaces, showing off an impressive solid oak top and sculpted concrete legs. Double drawers are featured for storage.



Dimensions

a. L120 W120 H42cm

b. L160 W47 H42cm

Standard finishes

Top / Legs:

1. Charred black oak / Acid black concrete
2. Seared oak / Grey concrete
3. Raw oak / Grey concrete

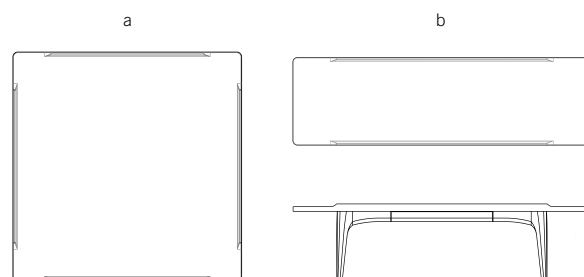
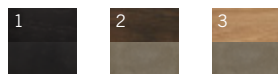



SALK SOFA

Inspired by the architecture of the Salk Institute, the Salk Sofa mixes solid oak and concrete with seat options in leather or fabric. A contemporary yet crafty design.



Dimensions

L250 W100 H72 SH50cm

Standard finishes

Seat / Base / Legs:

1. Paloma graphite / Charred black oak / Acid black concrete
2. Paloma shroom / Charred black oak / Acid black concrete
3. Paloma shroom / Seared oak / Grey concrete
4. French blue leather / Charred black oak / Acid black concrete
5. Ink black leather / Charred black oak / Acid black concrete
6. Sepia leather / Seared oak / Grey concrete

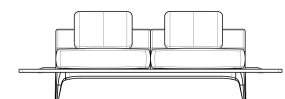
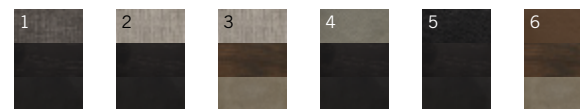
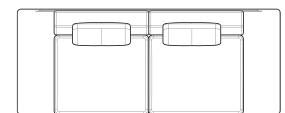



SALK ARMCHAIR

Inspired by the architecture of the Salk Institute, the Salk Armchair mixes solid oak and concrete with seat options in leather or fabric. A unique, crafty yet contemporary design piece.



Dimensions

L100 W100 H70 SH48cm

Standard finishes

Seat / Base / Legs:

1. Paloma graphite / Charred black oak / Acid black concrete
2. Paloma shroom / Charred black oak / Acid black concrete
3. Paloma shroom / Seared oak / Grey concrete
4. French blue leather / Charred black oak / Acid black concrete
5. Ink black leather / Charred black oak / Acid black concrete
6. Sepia leather / Seared oak / Grey concrete

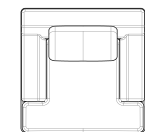
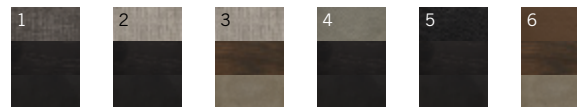

SALK CONSOLE

132

The Salk Console is a refined design, combining tall sculpted concrete legs and an elegant solid oak top. To match the various wood finishes, the concrete legs come in either classic grey or acid stained black.



Dimensions

L160 W47 H92cm

Standard finishes

Top / Legs:

1. Charred black oak / Acid black concrete
2. Seared oak / Grey concrete
3. Raw oak / Grey concrete

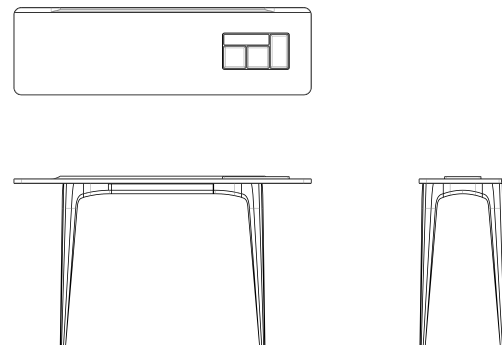
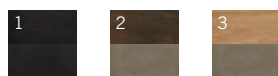

SALK DESK

133

The Salk Desk offers a mix of materials crafted to create a modern working space - solid oak top and sculpted concrete legs. Cable concealment and storage are featured for optimal workspace management.



Dimensions

L160 W70 H76cm

Standard finishes

Top / Legs:

1. Charred black oak / Acid black concrete
2. Seared oak / Grey concrete
3. Raw oak / Grey concrete

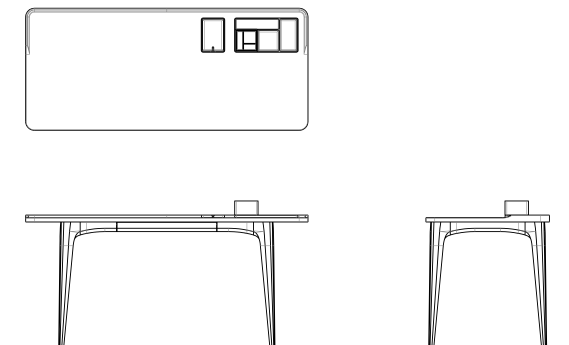
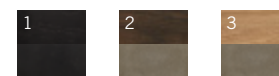

SALK BED

The contemporary Salk Bed is crafted with solid oak base and sculpted concrete legs. The padded backboard is upholstered in fabric.



Dimensions

a. King mattress north american	L273	W229	H92cm
b. Queen mattress north american	L229	W233	H92cm
c. King mattress standard	L229	W233	H92cm
d. Queen mattress standard	L225	W240	H92cm
e. King mattress asia	L225	W274	H92cm
f. Queen mattress asia	L249	W225	H92cm
g. King mattress taiwan	L263	W215	H92cm
h. Queen mattress taiwan	L217	W232	H92cm

Standard finishes

Top / Base / Legs:

1. Paloma graphite / Charred black oak / Acid black concrete
2. Paloma shroom / Charred black oak / Acid black concrete
3. Paloma graphite / Seared oak / Grey concrete
4. Paloma shroom / Seared oak / Grey concrete

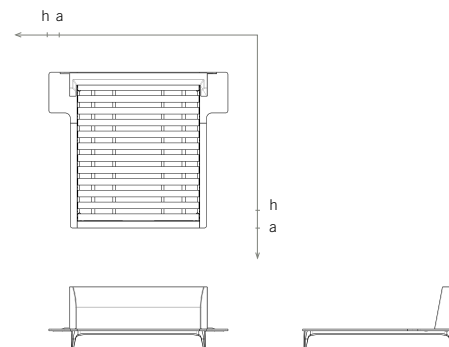

EXETER SIDE TABLE

136

137

The Exeter tables achieve perfect balance in combining a strong concrete base with a straight steel column tucked in a brass collar and a sharp and airy solid oak top. The Side Tables come as a statement, fitting to various seating area configurations.



Dimensions

- a. XL L70 W70 H41cm
- b. Low L55 W55 H46cm
- c. High L37 W37 H61cm

Standard finishes

- a. Top / Base
 - a.1. Charred black oak top / Acid black concrete
 - a.2. Seared oak / Grey concrete
 - a.3. Raw oak top / Grey concrete
- b. Top / Base
 - b.1. Black steel / Acid black concrete
 - b.2. Black steel / Grey concrete
- c. Top / Base
 - c.1. Charred black oak top / Acid black concrete
 - c.2. Seared oak / Grey concrete
 - c.3. Raw oak top / Grey concrete

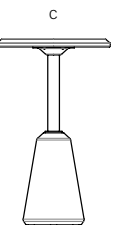
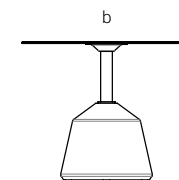
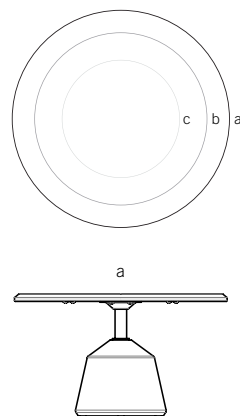
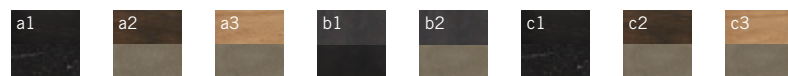

KAHN TRESTLE DINING TABLE

138

The Kahn Trestle Dining Table features a solid oak top supported by a base of cast concrete. The concrete base comes in either acid black or grey to offset with the natural oak wood perch. The inspiring brutalist architecture is here refined for contemporary spaces.



Dimensions

- a. L280 W120 H75cm
- b. L220 W100 H75cm
- c. L180 W90 H76cm

Standard finishes

Top / Legs:

- 1. Charred black oak / Acid black concrete
- 2. Seared oak / Grey concrete
- 3. Raw oak / Grey concrete



The Drift storage collection includes shelves, cabinets and drawers to create a functional wall system that allows to organise home & office. All are made from rustic oak veneer and solid oak, with steel tops and hand-crafted brass drawer pulls.



Dimensions

a. Drift 2 - door cabinet	L100	W42	H42cm
b. Drift drop-down cabinet	L100	W42	H32cm
c. Drift double drawer unit	L50	W42	H32cm
d. Drift long shelf	L100	W21	H6cm
e. Drift short shelf	L50	W21	H6cm

Standard finishes

Base / Drawer pulls + Black steel top:

- a.1. Cerused oak / Stainless steel
- a.2. Smoked oak / Brass
- a.3. Hard fumed oak / Brass
- a.4. Raw oak / Brass

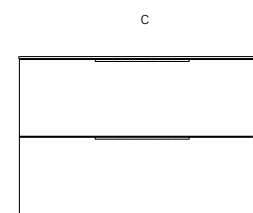
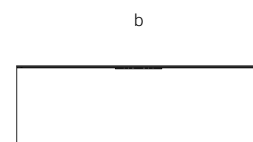
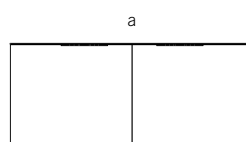
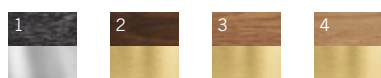



Diego nuance - 1005



Diego nehru - 1006

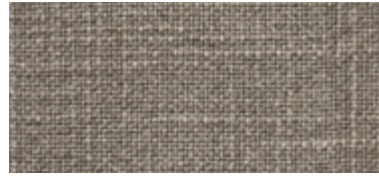

Diego melba - 1007

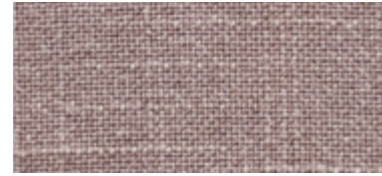

Paloma graphite - 1008



Paloma shroom - 1009



Velvet limestone - 1014



Velvet raffia - 1015



Velvet petal - 1016



Velvet pewter - 1017

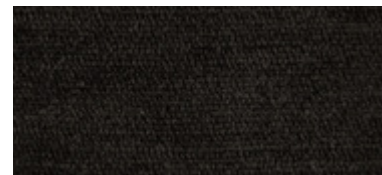

Velvet rust - 1018



Velvet gold - 1022



Tweed sesame - 1019



Tweed squirrel - 1021

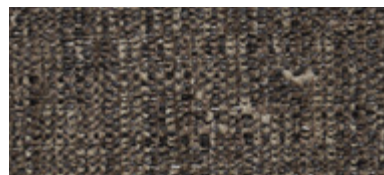

Arda pearl - 1023



Arda thunder - 1037



Arda cola - 1025

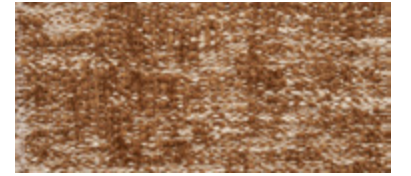

Arda monsoon - 1026

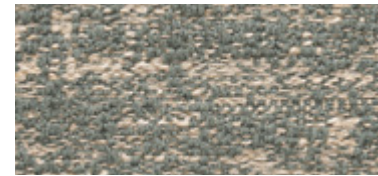

Arda caviar - 1033



Gema pearl - 1027

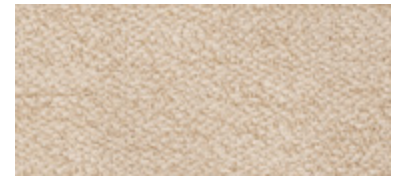

Gema thunder - 1036



Gema cola - 1029

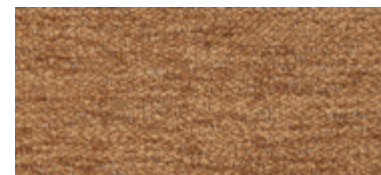

Gema monsoon - 1030



Gema caviar - 1034



Bouclé grey - 1031



Bouclé beige - 1032

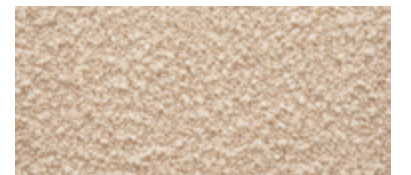

Bouclé cream - 1035



WOOD

Raw oak - VOO, MOO



Hard fumed oak - VHO, MHO



Smoked oak - VKO, MKO



Seared oak - VSO, MSO

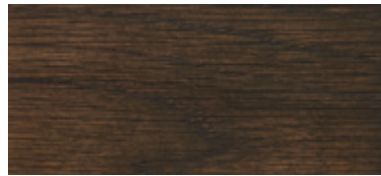

Charred black oak - VCO, MCO



Cerused oak - MLO

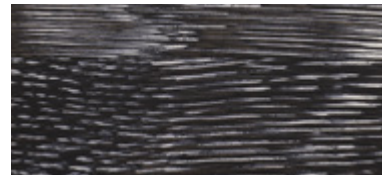

Faded oak - MFO

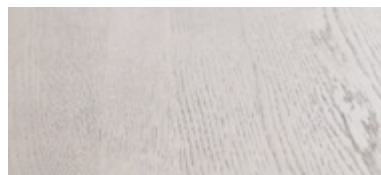

CONCRETE

Acid black

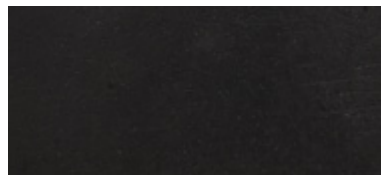

Grey

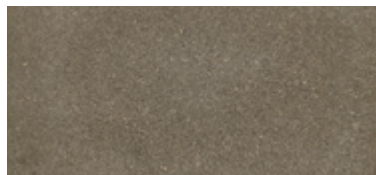

LEATHER

Ink black - IB



French blue - FB

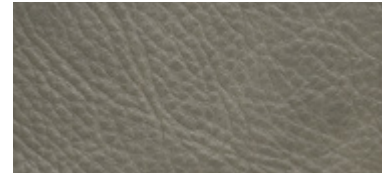

Sepia - SE

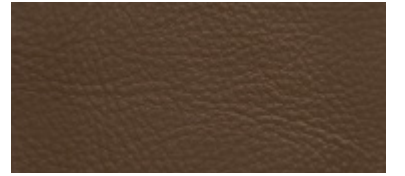

Cordova - CO

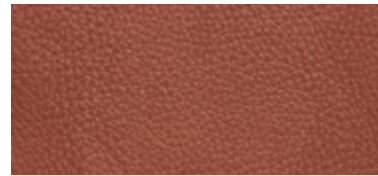

Mustard - MU



Jin - J



Umber - U

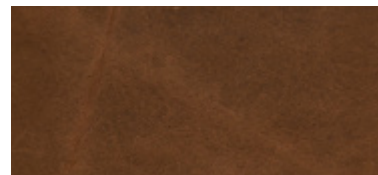

Storm - T

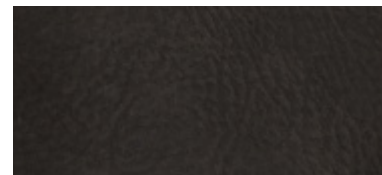

MARBLE

Nero

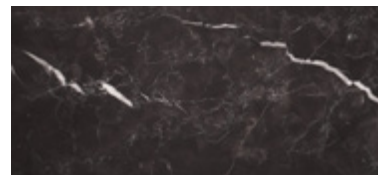

White

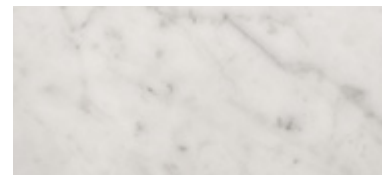
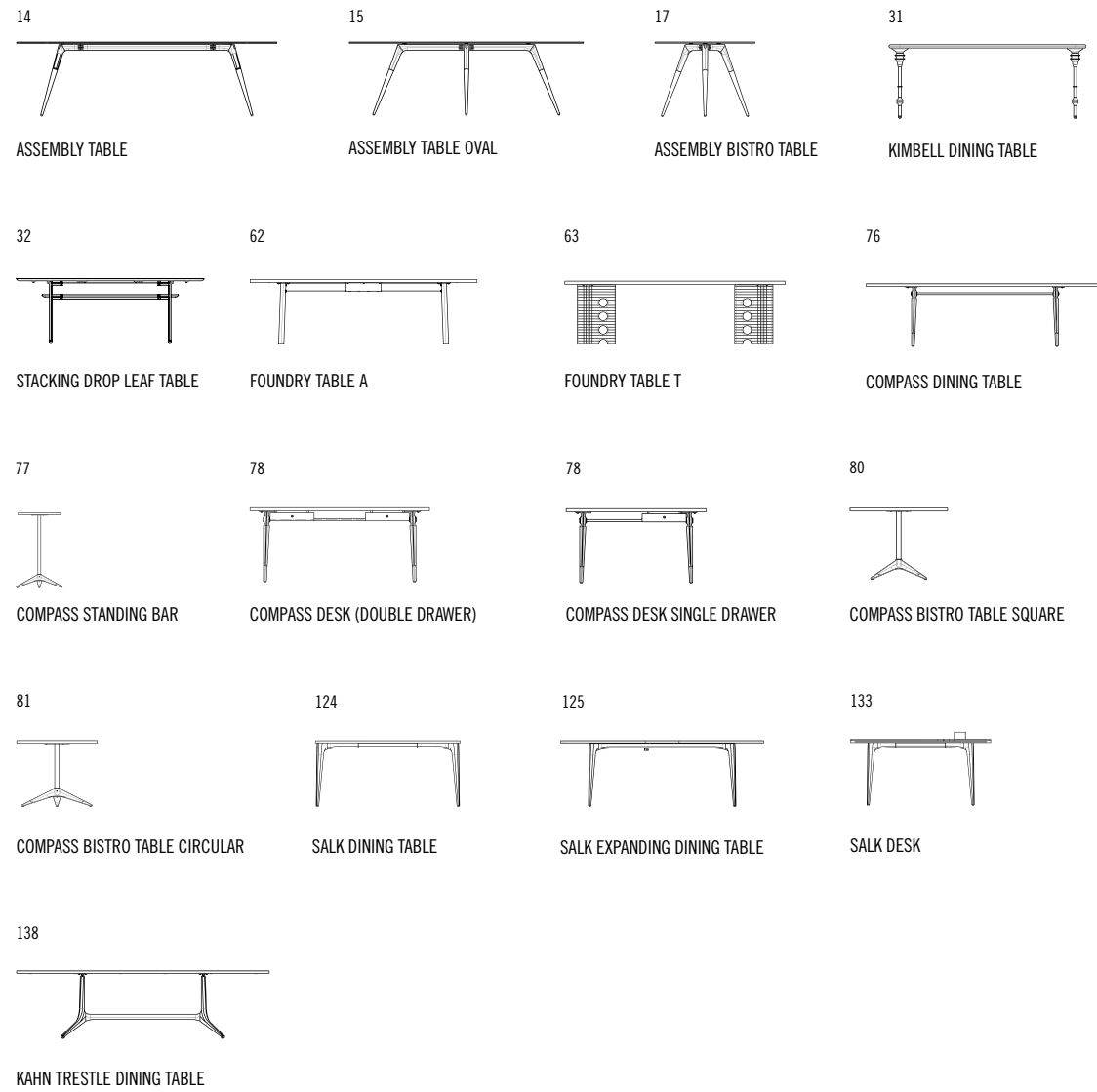
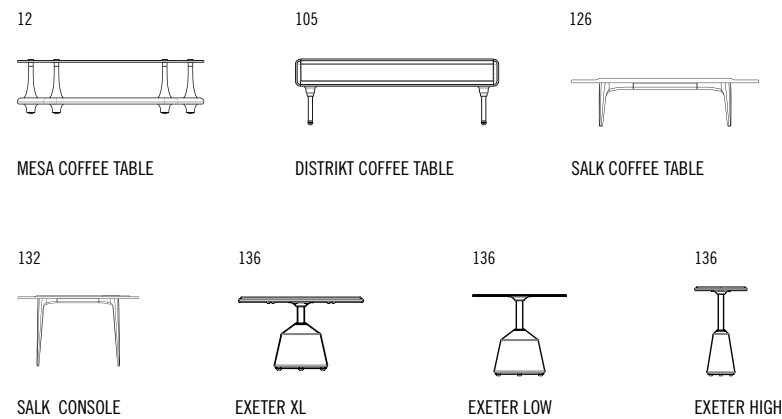

TABLE & DESKS

148



OCCASIONAL TABLES



CHAIRS, BENCHES & STOOLS

149

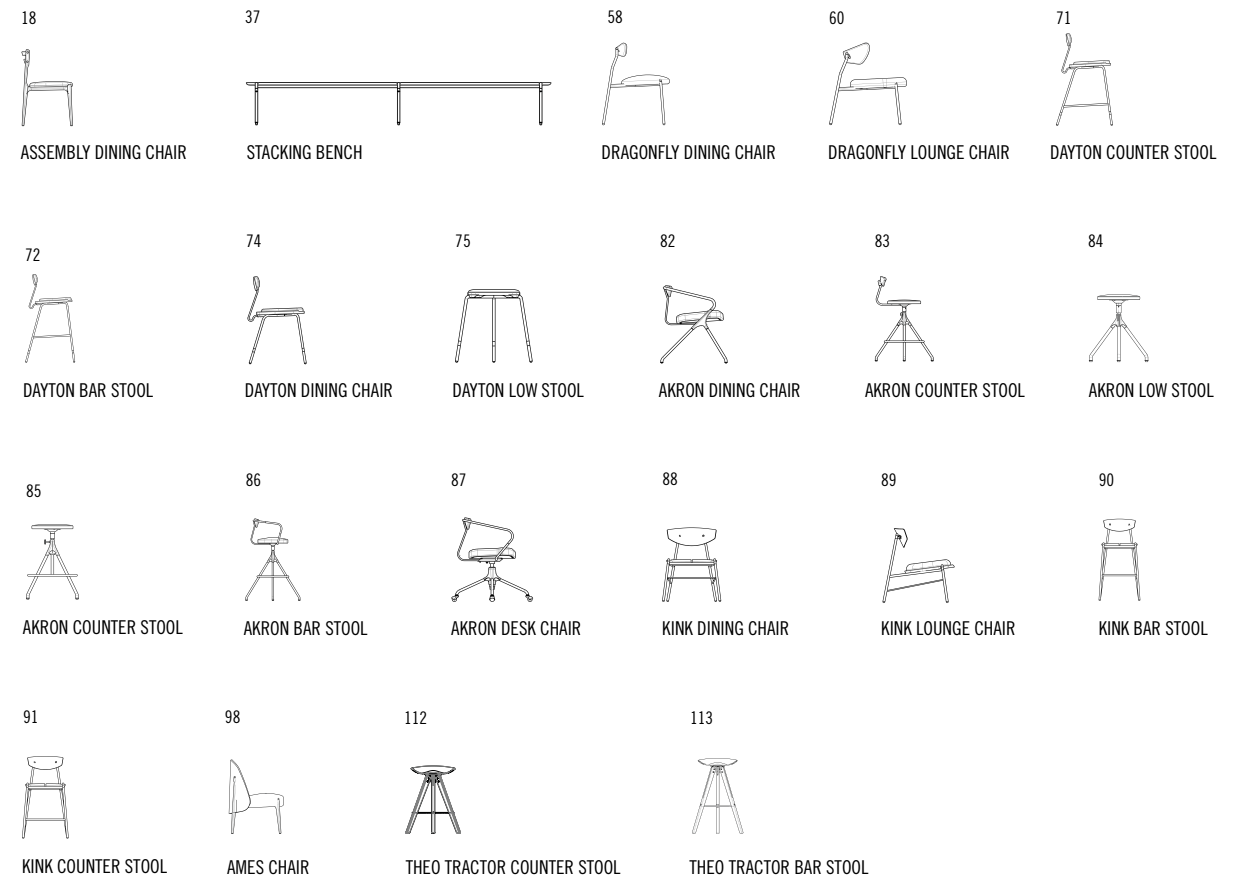

UPHOLSTERED CHAIRS & SOFAS

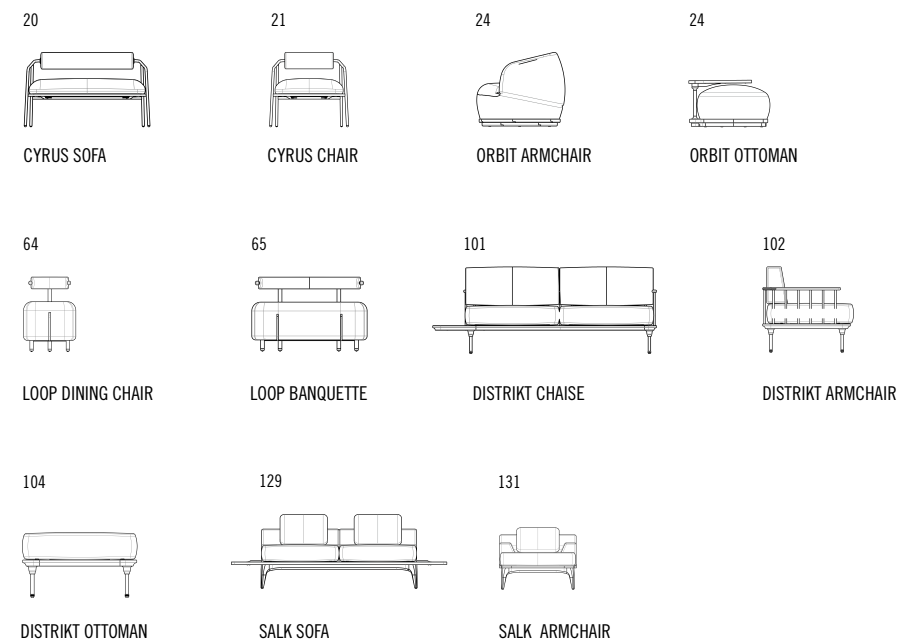

BEDROOM & STORAGE

109

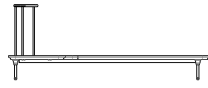

DISTRIKT BED

110

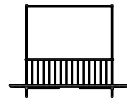

DISTRIKT CANOPY BED

134



SALK BED

37



STACKING BENCHES AS SHELVES

38

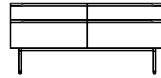

STACKING HIGH CABINET

40

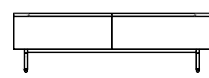

STACKING MEDIUM CABINET

41

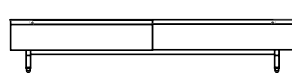

STACKING LOW CABINET

106

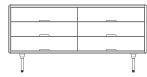

DISTRIKT DRESSER

107



DISTRIKT TALLBOY

108



DISTRIKT TROLLEY

114



THEO WALL UNIT CLOTHING RAIL

114



THEO WALL UNIT WITH CABINET

114



THEO WALL UNIT WITH BAR

115



THEO WALL UNIT CLOTHING RAIL WITH DRAWER

115



THEO WALL UNIT WITH DESK

115



THEO WALL UNIT WITH LARGE SHELVES

115



THEO WALL UNIT WITH MEDIUM SHELVES

140



DRIFT 2-DOOR CABINET

140

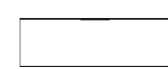

DRIFT DROP-DOWN CABINET

140



DRIFT DOUBLE DRAWER UNIT

140



DRIFT LONG SHELF

140



DRIFT SHORT SHELF

GAMES

49



FOOSBALL TABLE

50



PING-PONG TABLE

52



SHUFFLEBOARD TABLE

53

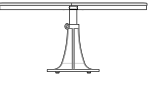

POKER TABLE

ACCESSORIES

27



ROUND MIRROR

116



HALLWAY MIRROR

117



HALF CIRCLE MIRROR

118



FLOOR MIRROR





Ho Chi Minh City, a.k.a. Saigon, has emerged as a global city in ways that few can imagine. Since 2010, when District Eight was founded, our home evolved from recognizable layers and textures of French colonial and mid-century modernist styles, to a new, continuously shifting identity. From pre- and post-war design realities to a furnace of emerging and diverging inspirations. In this new Vietnam, there is infinite room to grow. Our ideas and craftsmanship have also evolved in such a vibrant environment, while our mission remains: to offer the world distinct modern furniture, created in contemporary Vietnam.

CRAFTED FOR LIFE.

DISTRICT EIGHT DESIGN OFFICE, SHOWROOM & FACTORY

E4/52, 1A Highway, Binh Tri Dong B Ward,
Binh Tan District, Ho Chi Minh City, Vietnam

(+84) 28 38 170 311 or (+84) 28 38 170 312

Sales, projects, technical requests:
info@districteight.com

DISTRICTEIGHT.COM

