

DARØ®

Surprisingly clever

Darø design

BELL+ ARKITURBINE TRION GALILEI GISARIO FIORA COSTA ARCHOS TEE ARCHITECT PASO TRI

Light is more than just light. Proper lighting enhances the beauty, shapes, spaces and surroundings and adds depth to the way we experience them. Light infuses us with life and happiness.

For three generations we have been working to design and develop light for homes and workplaces, but most of all for people. We are proud to present Darø's collection of design lamps and introduce brand new designs that beautifully complement our traditional and iconic designs.

Our vision has always been to design lamps that create value and arouse enthusiasm. The design is determined by the light and the light is determined

by its function. The combination of innovative solutions, elegant finishes, colours and functions yields a product of enduring value.

We want more than just a lamp. We want to show you the light. We are more than a design brand.

Welcome into our bright universe!

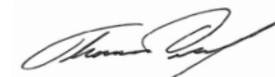

Thomas Darø
CEO



BELL+ / design by Thomas Holst Madsen

Bell+ is a lamp that confronts our usual perception of lamps as something static. Thomas Holst Madsen has designed a contemporary lamp which is ideal for use in restaurants, cafés, hotels, retail stores, conference rooms and private homes. The simple suspension, the implementation of a bar on which the shade hangs and the addition of the tilting function has created a unique lamp. The distribution of light is essential to the design and the lighting effects generated through the sides and top of Bell+ were important design features from the beginning.

Bell+ er en lampe, der udfordrer vores opfattelse af en lampe som værende noget statisk. Thomas Holst Madsen har designet en moderne lampe, der er ideel til indretning i restauranter, cafe-miljøer, hoteller, butikker og private hjem. Den simple ophængningsteknik, staven skærmen hænger på, og tilføjelsen af vippe-funktionen har gjort Bell+ til en unik lampe. Distributionen af lys har været afgørende for designet og lys-effekterne i siden og toppen var fra begyndelsen vigtige designværdier.

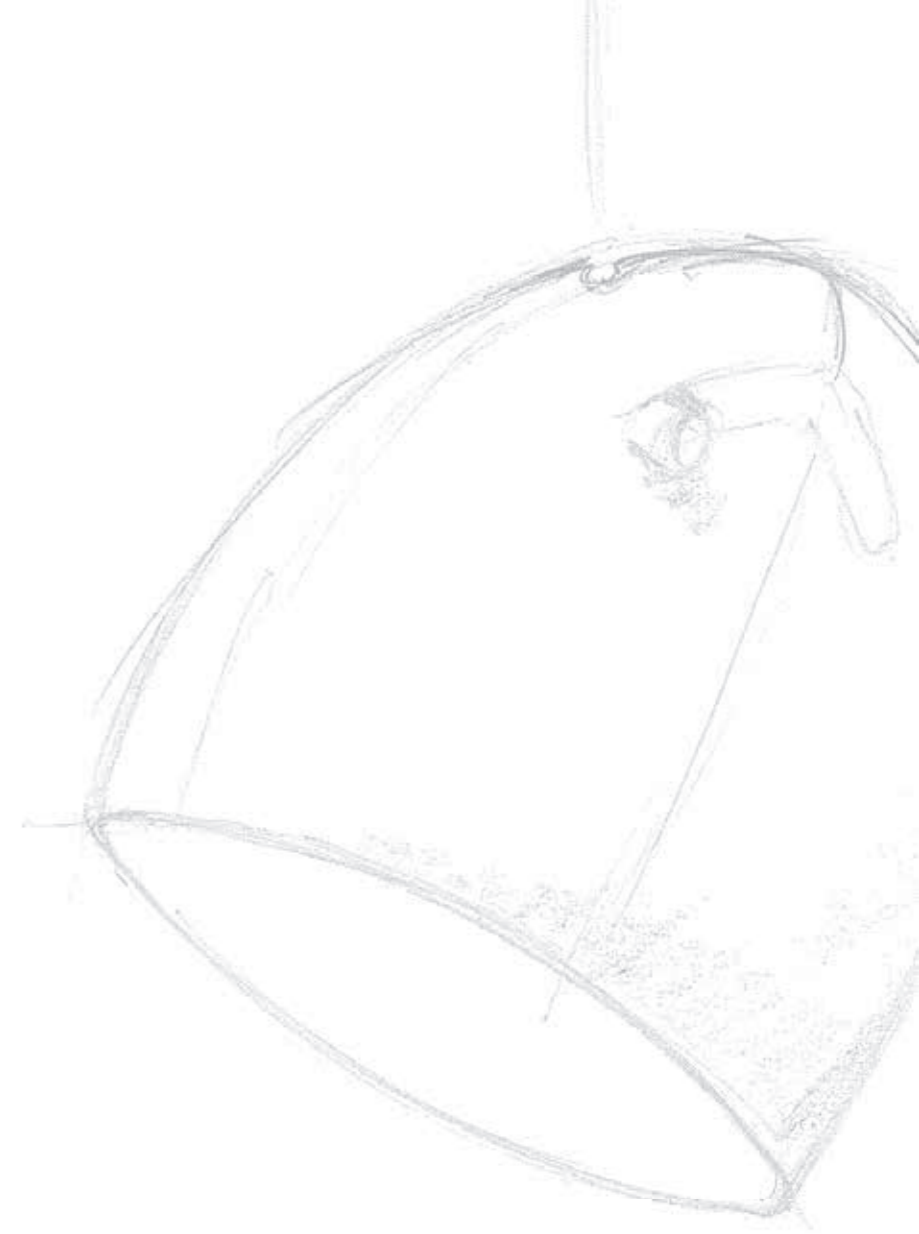

German
Design Award
SPECIAL
MENTION 2015

AWARD 2014
DESIGN PLUS
powered by light+building



BELL+ / design by Thomas Holst Madsen

BELL+ P1

COLOURS

20 / 30 / 50 / 70 P1 - Matt white
 20 / 30 / 50 / 70 P1 - Matt black
 20 / 30 P1 - Rose copper

LIGHT SOURCE

20 P1 max. 60W - E27 - 240V excl.
 30 P1 max. 100W - E27 - 240V excl.
 50 P1 max. 100W - E27 - 240V excl.
 70 P1 max. 100W - E27 - 240V excl.

INSTALLATION

P1. Class II, 3m textile cable, with canopy

MATERIAL

Aluminium shade / oak bar

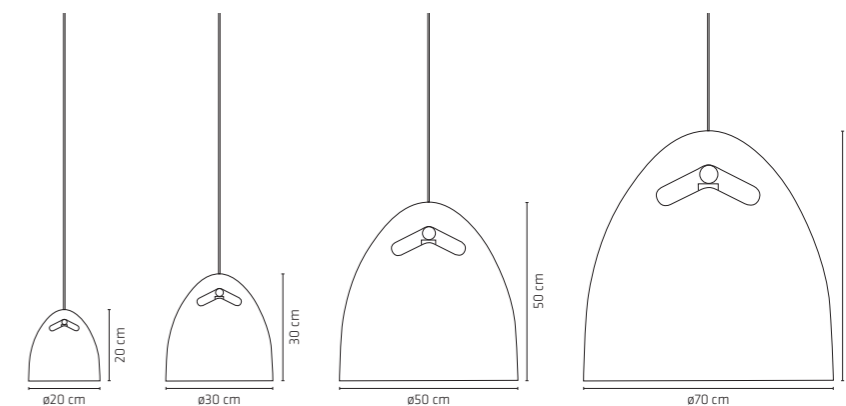



BELL+ / design by Thomas Holst Madsen

BELL+ 30 PT



"Bell+ is more than a lamp"

BELL+ 30 P1



BELL+ / design by Thomas Holst Madsen

BELL+ P1

COLOURS

20 / 30 / 50 / 70 P1 - Matt white
20 / 30 / 50 / 70 P1 - Matt black
20 / 30 / 50 P1 - Rose copper

LIGHT SOURCE

20 P1 max. 60W - E27 - 240V excl.
30 P1 max. 100W - E27 - 240V excl.
50 P1 max. 100W - E27 - 240V excl.
70 P1 max. 100W - E27 - 240V excl.

INSTALLATION

Class II, 3m textile cable, with canopy

MATERIAL

Aluminium shade / oak bar

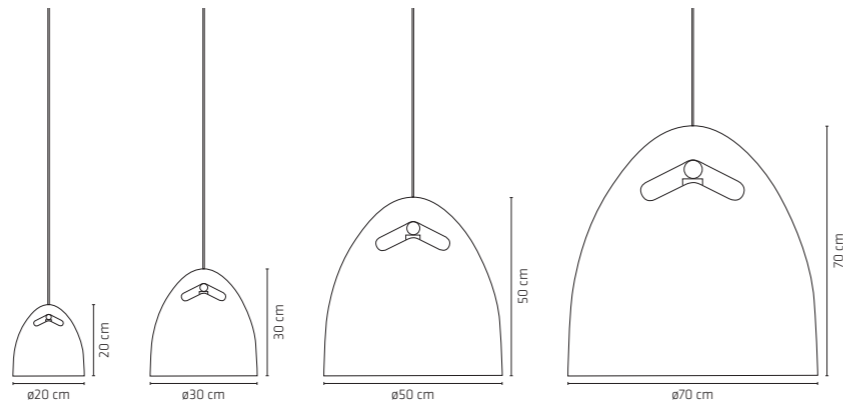





ARKITURBINE / design by Hans Christian Asmussen

The inspiration for Arkiturbine comes from a fundamental predilection for aesthetics, constructivism and asymmetry. The asymmetric structure of flowers and constructive aesthetics of an airship have been important sources of inspiration throughout the design process. Adding to this is the fascination of the asymmetry of a turbine which has been the focal point for the design.

Arkiturbine challenges the aesthetic expression which often characterises digital fabrication. Designer Hans Christian Asmussen has managed to create a soft and open form by only using digital fabrication with laser cut blades and frame. The construction method is simple and easily understood, but the result is surprising in its appearance.

Inspirationen til Arkiturbine stammer fra en grundlæggende forkærlighed for æstetik, konstruktivisme og asymmetri. Den asymmetriske opbygning af en blomst og et luftskibs konstruktive æstetik har været vigtige inspirationskilder i udviklingsprocessen. Dertil kommer fascinationen af en turbines asymmetri, der har været omdrejningspunktet for designet.

Arkiturbine er produceret ved hjælp af digital fabrikation og bryder med den konventionelle måde at tænke lapedesign på. Designer Hans Christian Asmussen har formået at skabe en blød og åben form udelukkende ved brug af digital fabrikation med laserskårne blade og stel. Konstruktionsmetoden er enkel og letforståelig, men resultatet er overraskende i sin fremtræden.





ARKITURBINE P1

COLOURS

30 / 50 / 70 P1 - White-Black

LIGHT SOURCE

30 P1 max. 60W - E27 - 240V excl.

50 P1 max. 100W - E27 - 240V excl.

70 P1 max. 100W - E27 - 240V excl.

INSTALLATION

P1. Class II, 3m black textile cable, with canopy

MATERIAL

Aluminium frame, plastic blades

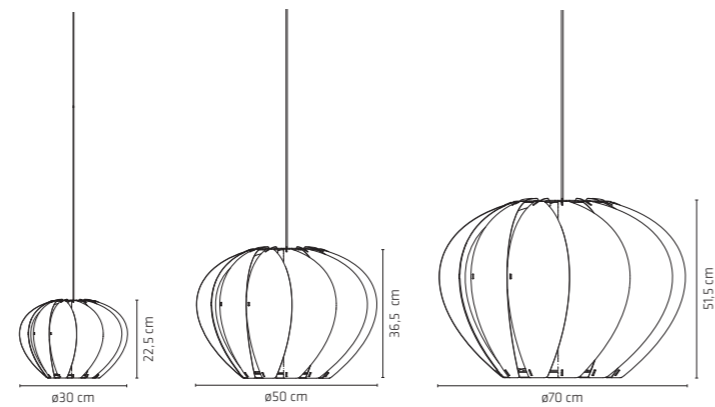

TRION / design by Thomas Darø





TRION / design by Thomas Darø

Trion has been designed based on core values from the original design which dates back to the early 80's. Trion is a contemporary lamp which can create design value in interior design both on the contract market and in private homes. Trion represents elegance, design and detail at its finest. The shade is made of aluminium and combined with the textile cable and the ceramic socket it ensures a long lifespan.

Trion er designet ud fra originale værdier, hvor dette design så dagens lys første gang i starten af 80'erne. Trion er en moderne lampe, der kan skabe designværdi i indretningen på både kontraktmarkedet og i private hjem. Trion repræsenterer elegance, design og detaljer på højeste plan. Skærmen er lavet af aluminium og kombineret med tekstilledningen og den keramiske sokkel har lampen en lang levetid.



TRION 45 P1



TRION 27 P1



TRION / design by Thomas Dørø

TRION P1

COLOURS

Matt white
Matt black
Rose copper

LIGHT SOURCE

27 P1 max. 60W - E27 - 240V excl.
35 P1 max. 100W - E27 - 240V excl.
45 P1 max. 100W - E27 - 240V excl.

INSTALLATION

Class II, 3m textile cable, with canopy

MATERIAL

Aluminium shade / aluminium suspension

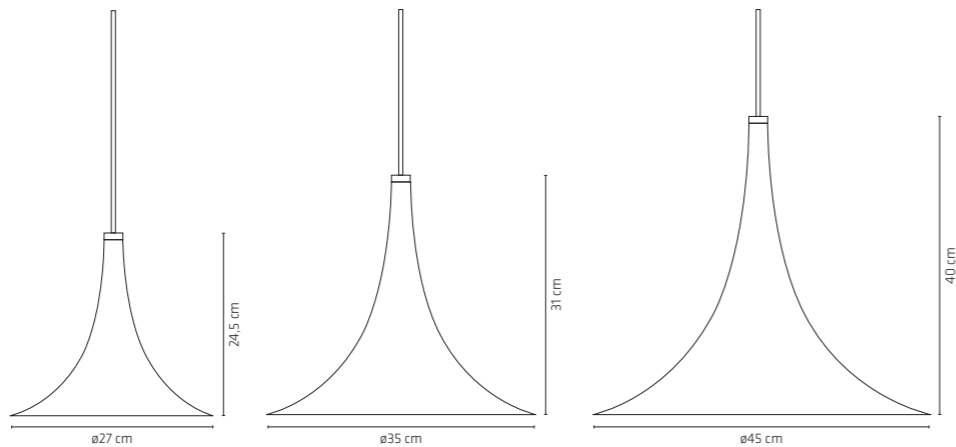



Trion is a contemporary lamp which can create design value in interior design both on the contract market and in private homes.



TRION / design by Thomas Darø

TRION P1

COLOURS

Matt white
Matt black
Rose copper

LIGHT SOURCE

27 P1 max. 60W - E27 - 240V excl.
35 P1 max. 100W - E27 - 240V excl.
45 P1 max. 100W - E27 - 240V excl.

INSTALLATION

Class II, 3m textile cable, with canopy

MATERIAL

Aluminium shade / aluminium suspension

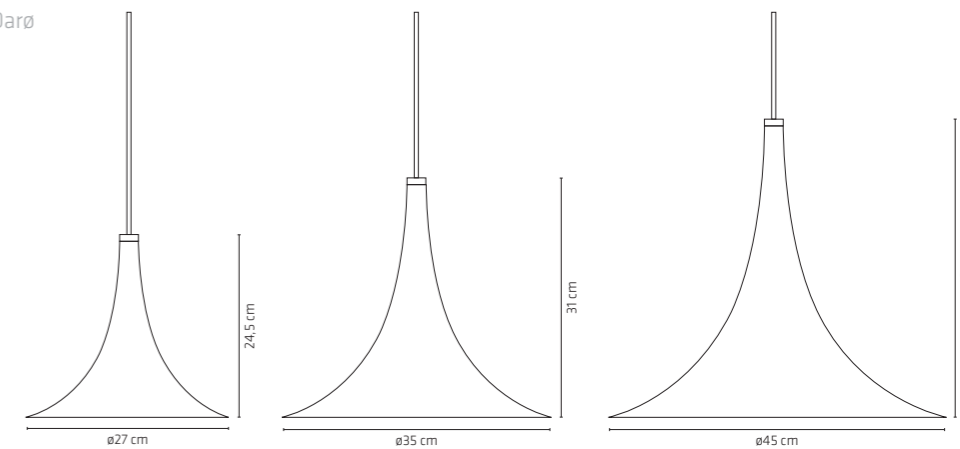



TRION / design by Thomas Darø

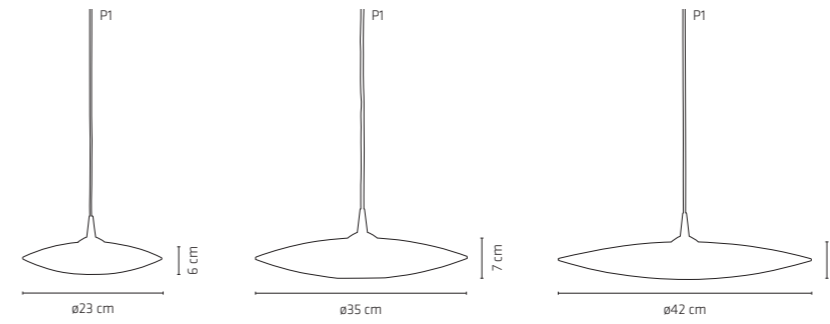

GALILEI P1 240V

COLOURS
Matt white

LIGHT SOURCE
40W - G9 - 240V incl.

INSTALLATION
Class II, 3m transparent cable, w/canopy

MATERIAL
Glass shade / satin chrome metal suspension



GALILEI / design by Thomas Darø

Galilei is one of Darø's icons. Style, elegance, quality and timelessness characterises Galilei. Each glass is made by hand and each lamp is carefully produced by hand. Galilei is made using matt white glass that casts a soft, pleasant and diffused light into the room. The light also shines directly down through an opening in the bottom of the glass and creates a spotlight effect on the table.

Galilei er ét af Darø's ikoner. Stil, elegance, kvalitet og tidløshed karakteriserer Galilei. Hvert glas er lavet i hånden og hver lampe er forsigtigt produceret i hånden. Galilei er lavet af mat-hvide glas, der kaster et blødt, behageligt og diffust lys i rummet. Lyset skinner også direkte ned gennem en åbning i bunden af glasset og skaber dermed en spotlight-effekt på bordet.





GISARIO 15 W1 / WHITE



GISARIO 15 W1 / BLACK



GISARIO 15 W1 / SATIN CHROME

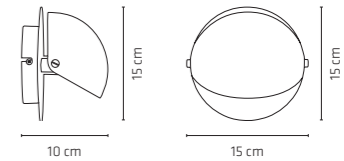
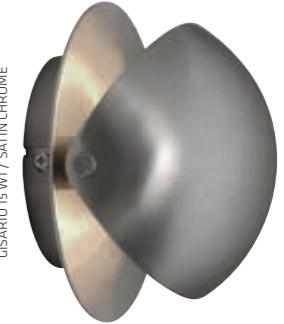

GISARIO / design by Kjeld Darø

Gisario is made of a solid metal and is a versatile element in Darø's line of wall lamps. The surface is finished with a matt textured paint evoking a calm, exclusive finish. The lamp shade can be tilted up or down to direct the light which provides interesting and decorative effects. Gisario is a flexible lamp that can fulfil many demands in interior decoration in private homes and for projects.

Gisario er fremstillet i et solidt metalmateriale og er et alsidigt element i Darø's kollektion af væglamper. Overfladen er malet med en mat strukturmaling, der giver en rolig og eksklusiv finish. Skærmen kan vippes op eller ned, så man kan styre lysretningen med en spændende og dekorativ effekt. Gisario er en fleksibel lampe, der kan opfylde mange behov i indretningen af private hjem og til projekter.

GISARIO 15 W1

COLOURS

White
Black
Satin chrome

LIGHT SOURCE

48W - G9 - 240V excl.

INSTALLATION

Class II, 2m transparent cable, w/in-line switch and euro-plug

MATERIAL

Metal

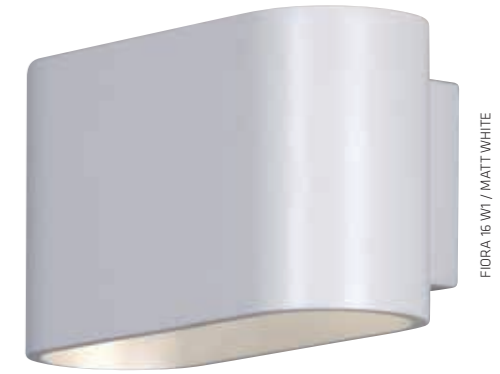

FIORA 16 W1 / MATT WHITE



FIORA / design by Thomas Dørø

Fiora is a classically and uniquely designed wall lamp that can be used in many settings. The simple design and the soft lines gives Fiora a modest look, but looking closer the sturdy aluminium shade radiates quality and durability. The reflective silver on the inside of the shade creates a fantastic effect and gives Fiora a very powerful look.

Fiora er en klassisk og unikt designet væglampe, der kan bruges i mange sammenhænge. Det enkle design og de bløde linjer giver Fiora et beskedent udtryk, men kigger man nærmere kan man ikke undgå at se den kraftige aluminiumsskærm udstråler kvalitet og holdbarhed. Det reflekterende sølv indvendig i skærmen skaber en fantastisk effekt, og giver Fiora et meget kraftfuldt udtryk.

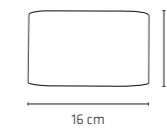
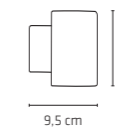

FIORA 16 W1

COLOURS
Matt white
Matt black

LIGHT SOURCE
33W - G9 - 240V excl.

INSTALLATION
Class II, 2m transparent cable,
w/in-line switch and euro-plug

MATERIAL
Aluminium



COSTA / design by Thomas Darø

Costa adds a cubistic look to Darø's beautiful range of wall lamps. Costa has been designed based on the same principles as our other popular wall lamps, and complements the Darø design line very well. The quality materials that have been used to produce Costa exude quality and durability. The 5 millimeter thick aluminum lamp shade gives a robust and sturdy impression while the reflective silver on the inside of the shade creates a fantastic effect.

Costa tilføjer et kubistisk look til Darø's flotte sortiment af væglamper. Costa's design er baseret på samme principper som vores andre væglamper, og bidrager til den røde tråd i Darø's designlinje. De kvalitetsmaterialer, der er brugt til at lave Costa udstråler kvalitet og holdbarhed. Den 5 millimeter tykke aluminiumsskærm giver et robust og holdbart udtryk, mens det reflekterende sølv indvendig på skærmen skaber en fantastisk effekt.

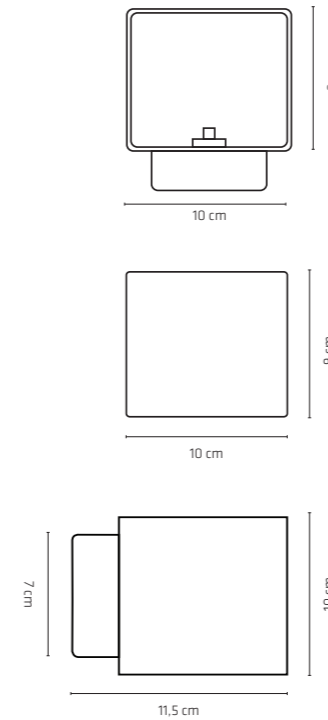

COSTA / design by Thomas Darø

COSTA 10 W1

COLOUR
Matt black
Matt white

LIGHT SOURCE
33W - G9 - 240V excl.

INSTALLATION
Class II, 2m transparent cable,
w/in-line switch and euro-plug

MATERIAL
Aluminium

COSTA / design by Thomas Darø



COSTA 10 W1

COLOUR
Matt black
Matt white

LIGHT SOURCE
33W - G9 - 240V excl.

INSTALLATION
Class II, 2m transparent cable,
w/in-line switch and euro-plug

MATERIAL
Aluminium

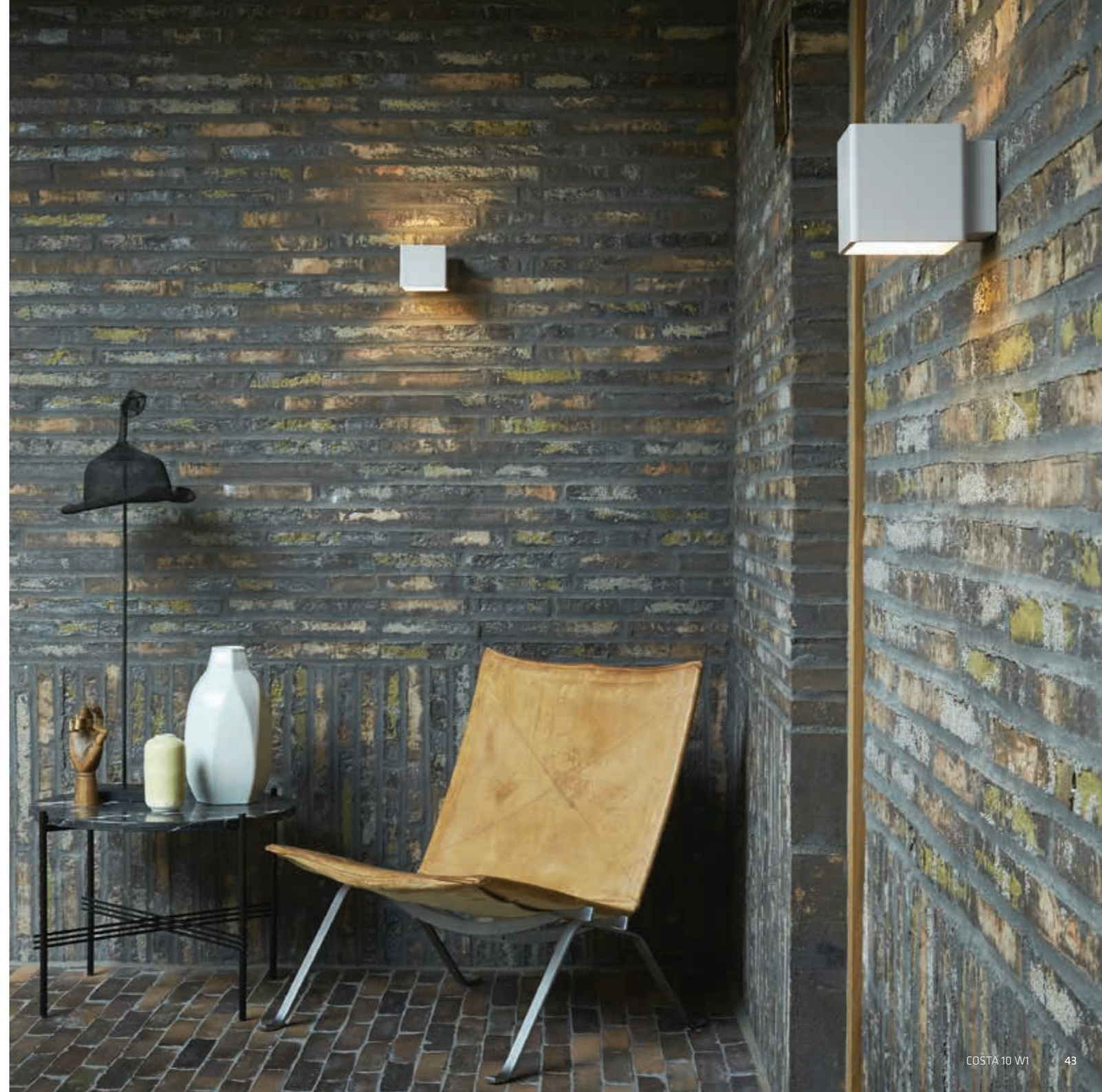
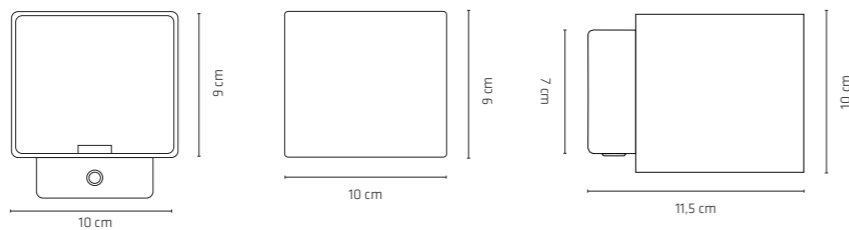



ARCHOS 18 W1 / MATT WHITE

ARCHOS 18 W1

COLOUR
Matt black
Matt white

LIGHT SOURCE
33W - G9 - 240V excl.

INSTALLATION
Class II, 2m transparent cable,
w/in-line switch and euro-plug

MATERIAL
Aluminium

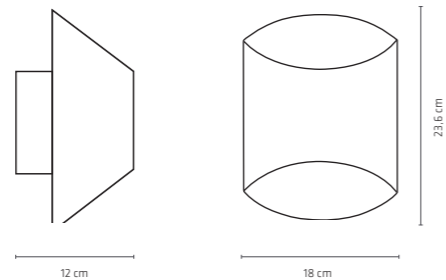

ARCHOS / design by Thomas Darø

With its sturdy aluminium shade Archos has been designed to radiate elegance, quality and durability. The exterior matt finish provides a great contrast to the reflective silver on the inside of the shade - which in itself creates synergy with the light source. Archos was originally designed to be placed next to flat screens or in stairway and it is the ideal choice when elegant wall lighting is required for the contract market.

Med sin kraftige aluminiumsskærm er Archos designet til at udstråle elegance, kvalitet og holdbarhed. Den udvendige, matte farve skaber en flot kontrast til det reflekterende sølv indvendig i skærmen, der i sig selv skaber en synergieffekt med lyskilden. Archos var oprindeligt designet til ophæng ved siden af en fladskærm eller i trappeopgange, og er det ideelle valg, når der skal bruges elegant vægbelysning på projektmarkedet.





ARCHOS / design by Thomas Darø

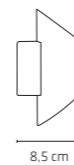

8.5 cm

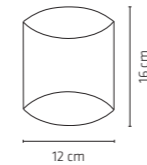

12 cm

16 cm

ARCHOS 12 W1

COLOUR
Matt black
Matt white

LIGHT SOURCE
33W - G9 - 240V excl.

INSTALLATION
Class II, 2m transparent cable,
w/in-line switch and euro-plug

MATERIAL
Aluminium



ARCHOS 12 W1 / MATT WHITE



ARCHOS 12 W1 / MATT BLACK



TEE / design by Thomas Darø

“Be inspired - play the ball”. Tee’s design is inspired by the perfect, fascinating balance between golf ball and tee. The integrated magnetic system provides a flexible and functional option of controlling the direction of the light. Like all Darø’s lamps Tee has been produced using only the best materials that signify quality and durability.

“Be inspired - play the ball”. Tee’s design er inspireret af den perfekte, fascinerende balance mellem golfbold og tee. Det integrerede system gør Tee fleksibel og funktionel, da man selv kan bestemme retningen af lyset. Lige som alle Darø’s lamper er Tee blevet produceret udelukkende ved brug af de bedste materialer, der garanterer kvalitet og holdbarhed.

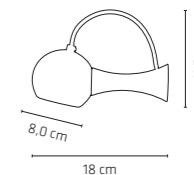

TEE W1 LED

COLOURS

Matt white
Matt black
Matt ivory

LIGHT SOURCE

5,5W led - Gu10 - 240V incl.

INSTALLATION

Class II, 2m transparent cable,
w/in-line switch and euro-plug

MATERIAL

Metal shade / chrome aluminium base



ARCHITECT / design by Thomas Darø

The angular shapes and futuristic design softened by a lightly-brushed satin aluminium finish are some of the first obvious features of Architect. Closer inspection reveals the internal wire system which elegantly unifies strength and refinement. The architectural lamp is an old design classic and Darø's Architect provides a contemporary and different model to what has already been seen.

De rektangulære former og det futuristiske design, der blødes op af en let børstet satin aluminium finish, er det første man ligger mærke til ved Architect. Tættere på kan man se det interne wiresystem, der sikrer styrke og elegance. Arkitektlampen er en gammel designklassiker, og Darø's Architect er en moderne og anderledes model i forhold til hvad der tidligere er set.

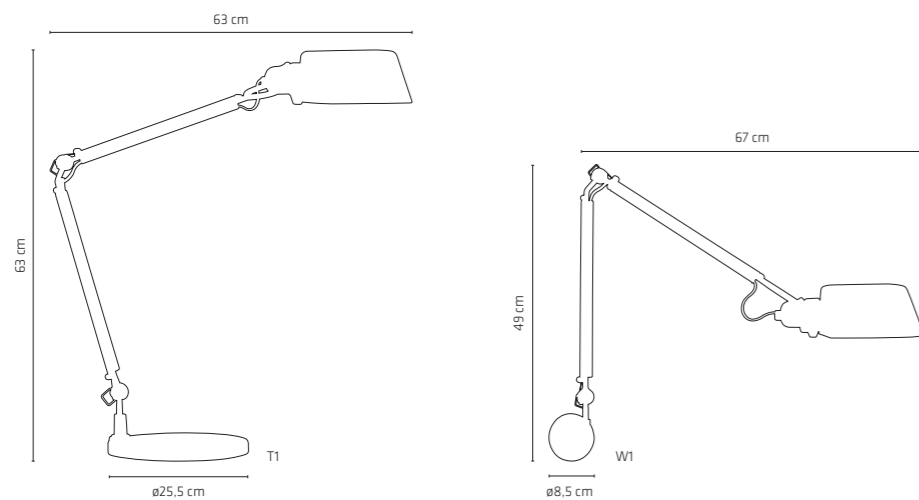

ARCHITECT W1/T1

COLOUR
Aluminium

LIGHT SOURCE
60W - E27- 240V excl.

INSTALLATION
Class II, 2 m transparent cable, switch on head

MATERIAL
Aluminium



3 PASO
designs

120 PASO Universe
combinations



PASO

The basic colour is black

The beautiful Paso collection of has a simple contemporary look and creates exciting design values in interior decoration. The basic colour for Paso is black which exudes aesthetics and design. Paso has been designed with the black colour as basis to create a timeless and classic lamp and it has been produced using the best materials. The simple design makes the lamp easy to assemble and the entire collection has great coherence.

Den flotte Paso kollektion har et simpelt, moderne udtryk og skaber en spændende designværdi i indretningen. Basisfarven for Paso er sort, hvilket signalerer æstetik og design. Paso er designet med den sorte farve som udgangspunkt for at skabe en tidløs og klassisk lampe, og den er produceret ved brug af de bedste materialer. Det simple design gør lampen let at samle selv, og hele kollektionen har flot samhörighed.

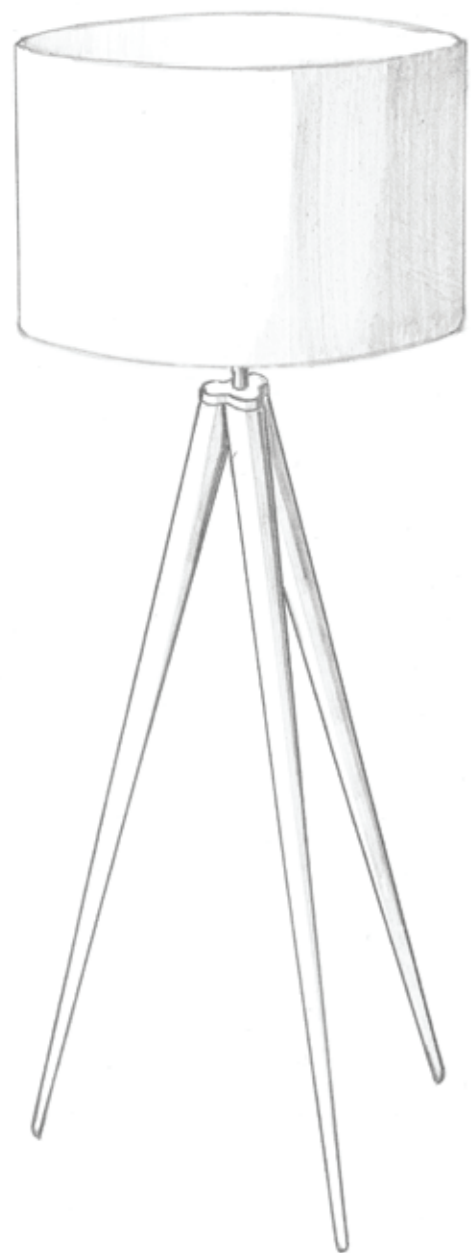

PASO TRI / design by Thomas Darø

Paso Tri is a new element in Darø's original Paso collection. The design follows the same simple style, but the combination of all the little changes creates a completely new lamp. The inspiration for Paso Tri comes from a cloverleaf - beautiful and iconic. The edges have been rounded which brings a visually softer expression with more feminine features. Paso Tri is a uniquely designed lamp and in the design process focus has constantly been on quality, expression and concept.

Paso Tri er et nyt element i Darø's originale Paso-serie. Stilen er holdt i samme simple udtryk, men kombinationen af de små ændringer skaber sammenlagt en helt ny lampe. Inspirationen til Paso Tri kommer fra trekløveret - smukt og ikonisk. Kanterne er nu runde, og det skaber visuelt et blødere udtryk med mere feminine træk. Paso Tri er en unikt designet lampe, hvor der i designprocessen altid har været fokus på kvalitet, udtryk og formsprog.



PASO TRI / design by Thomas Darø

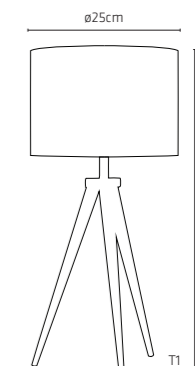
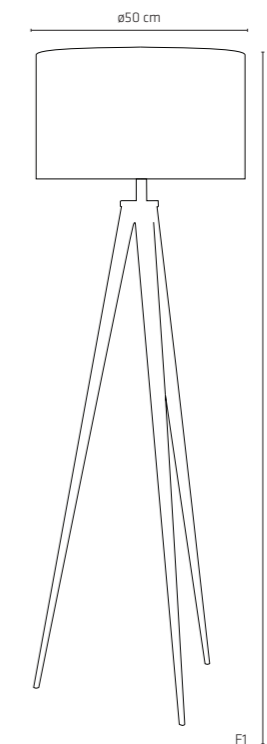

PASO TRI 50 F1

COLOURS
Black-black

LIGHT SOURCE
100W - E27 - 240V excl.

INSTALLATION
Class II, 2m cable,
w/foot-switch
and euro-plug

MATERIAL
Metal / textile

PASO TRI 25 T1

COLOURS
Black-black

LIGHT SOURCE
60W - E27 - 240V excl.

INSTALLATION
Class II, 2m cable,
w/in-line switch
and euro-plug

MATERIAL
Metal / textile

Paso is a contemporary lamp which is ideal for use in restaurants, cafées, hotels, retail stores, conference rooms and private homes.

PASO Pendants



PASO 25/35/50 P1

COLOURS
Black-black

LIGHT SOURCE
60W - E27 - 240V excl.

INSTALLATION
Class II, 3m black
textile cable, with canopy

MATERIAL
Metal / textile / acrylic

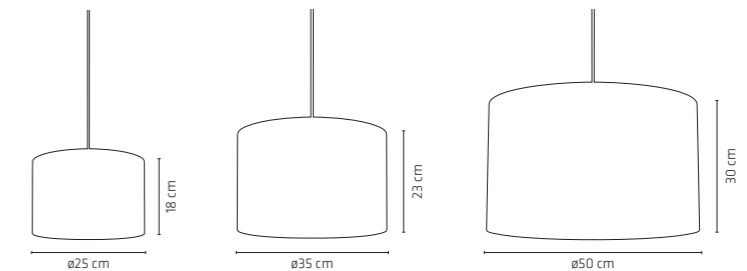

CLASSIC BLACK



PASO 25 P1



PASO 35 P1



PASO 50 P1



PASO TRI / design by Thomas Darø





PASO Universe

Imagine the possibilities

Paso Universe makes room for creativity and individual design. With the unique patented shade system it is easy to change to a coloured textile so it is possible to create a lamp that matches an exact style and interior decoration. The Paso pendant offers yet another optional element with the beautiful textile cords of high quality in different colours. Let the creativity decide.

Paso Universe giver plads til kreativitet og individuel design. Med det unikke patenterede skærmsystem er det nemt at skifte til et farvet tekstil, så man kan skabe en lampe, der passer præcis til ens egen stil og indretning. Paso pendlen byder på endnu et valgfrit element med de flotte tekstilledninger af høj kvalitet i flere forskellige farver. Lad kreativiteten bestemme.

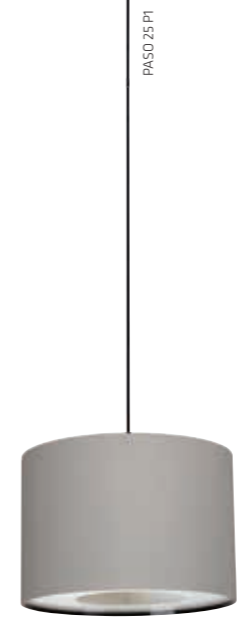

shades in grey

PASO Universe

Your own customised PASO



PASO Universe

Imagine the possibilities





Colours of the Universe

Get inspired and set your creativity free by designing your own PASO combination.

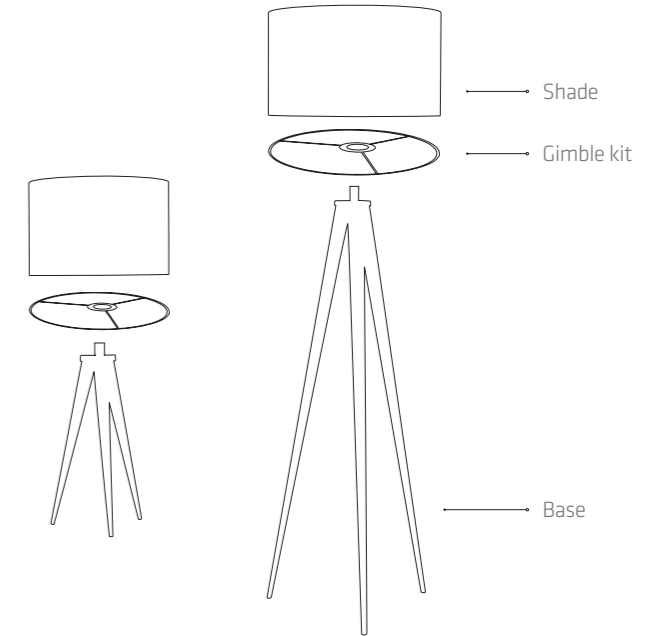
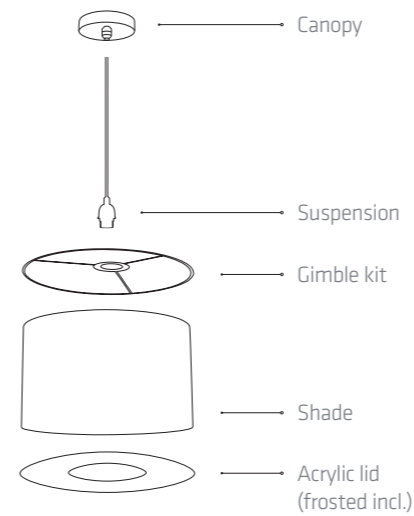

PASO E27 SUSPENSION

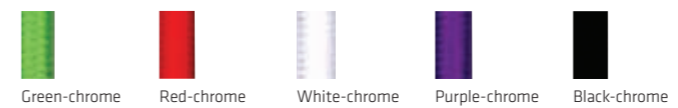

PASO 35+50 SHADE

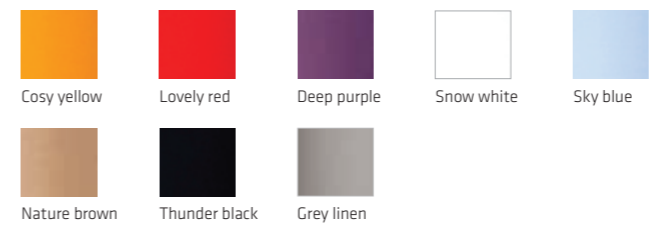

PASO 25 SHADE



Craftsmanship since 1969

Our vision has always been to design lamps that create value and arouse enthusiasm. The design is determined by the light and the light is determined by its function.

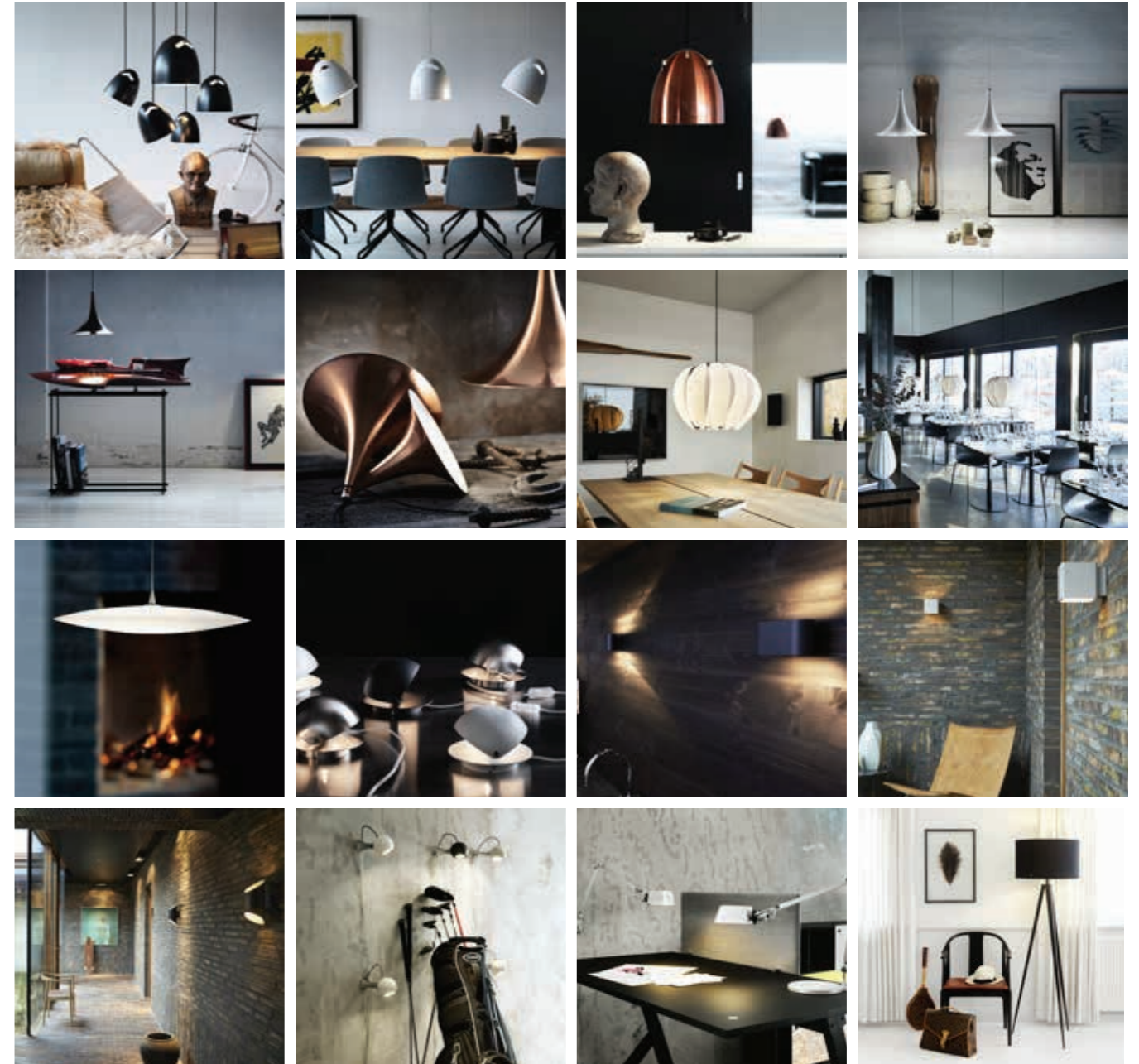

Our designers



Kjeld Darø

Design / GISARIO



Thomas Darø

Design / ARCHITECT
ARCHOS
COSTA
FIORA
GALILEI
PASO
TEE
TRION



Thomas Holst Madsen

Design / BELL+
German Design Award 2015
Design Plus Award 2014



Hans Christian Asmussen

Design / ARKITURBINE
London Design Award 2015



Says Who

Design / PASO WOOD
RELEASE 2016

Head office

Darø a/s
Ribevej 8
8940 Randers SV
Denmark

Tel. + 45 86 43 50 66
mail@daroe.dk

Darø dealers

Find a dealer near you
– visit our website www.daroe.eu

