

Q.7

Emphasise the character
of your home.



:hager

A home
is always
a reflection
of the people
living in it.



A real home is always a reflection of the people living in it. Homes have personality and character, which can be perceived from shapes and colours, furniture, carpeting and accessories. This includes pieces of art – both big and small – and the books on the shelves.

We developed the Berker Q.7 with this in mind. The customised switch series brings new materials into play and opens up new possibilities for designing your home the way you want – with slate, concrete, aluminium, glass, plastic or stainless steel replacing compatible standards, so much individuality encourages thinking outside the box. Who says the switches in the living room have to be the same as those in the kitchen or bathroom?



Plastic



Slate



Concrete



Aluminium



Stainless steel



Glass



Special materials for special spaces.

Everybody is different.
Every home is different, too.
Why does every switch have to look the same? Six different materials open up a range of new possibilities to give your home that personal touch.

As simple as it is elegant.

The Berker Q.7 is a striking design with a translucent back plate that makes it appear as though it is suspended in mid-air.

Back plate material

Translucent
Thickness: 6 mm

Frame

Thickness: 4 mm





Q.7 Glass

Glass – whether dark or light – allows the interplay between light and reflections. A smooth, flat material with a timeless and exquisite finish. In this sense, the Berker Q.7 in glass reflects what the material can do. It is a stylish design, which lends a special contemporary elegance to spaces.

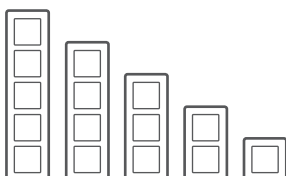

Materials

4 mm black glass, 6 mm back plate material

4 mm polar white glass, 6 mm back plate material

Frame combinations

1-gang to 5-gang, horizontal / vertical

Rocker switches available in

anthracite velvet, polar white velvet, aluminium velvet

Q.7

Aluminium

The high-tech material aluminium is not only exceptionally lightweight. It is also extremely appealing, with a matt, velvety finish that creates both a warm and elegant look. What's more, it is ultra-modern.

The Berker Q.7 in aluminium epitomises the meaning of spectacular.

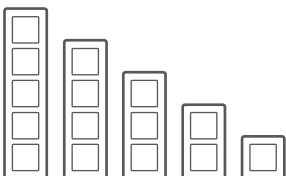

Material

4 mm anodised aluminium, 6 mm back plate material

Frame combinations

1-gang to 5-gang, horizontal / vertical

Rocker switches available in

anthracite velvet, polar white velvet, aluminium velvet





Q.7

Stainless steel

The Berker Q.7 in brushed stainless steel uniquely interprets this timeless material, with a structure and intentional surface roughness that conjures up ideas of exquisite craftsmanship. Used in this way, the metal – with its particularly high degree of purity – is equally striking and elegant.

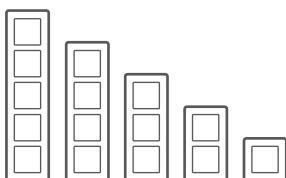

Material

4 mm brushed stainless steel, 6 mm back plate material

Frame combinations

1-gang to 5-gang, horizontal / vertical

Rocker switches available in

anthracite velvet, polar white velvet, aluminium velvet

Q.7 Slate

The Berker Q.7 in dark slate harks back to a material with a special look and feel. In its own way, slate is an elegant material, but one that could never be described as extravagant. The matt stone feels warm and strikes a chord when touched. In the truest sense of the word, slate is a real feature.



Material

4 mm natural slate, 6 mm back plate material

Frame combinations

1-gang to 3-gang, horizontal / vertical

Rocker switches available in

anthracite velvet, polar white velvet, aluminium velvet





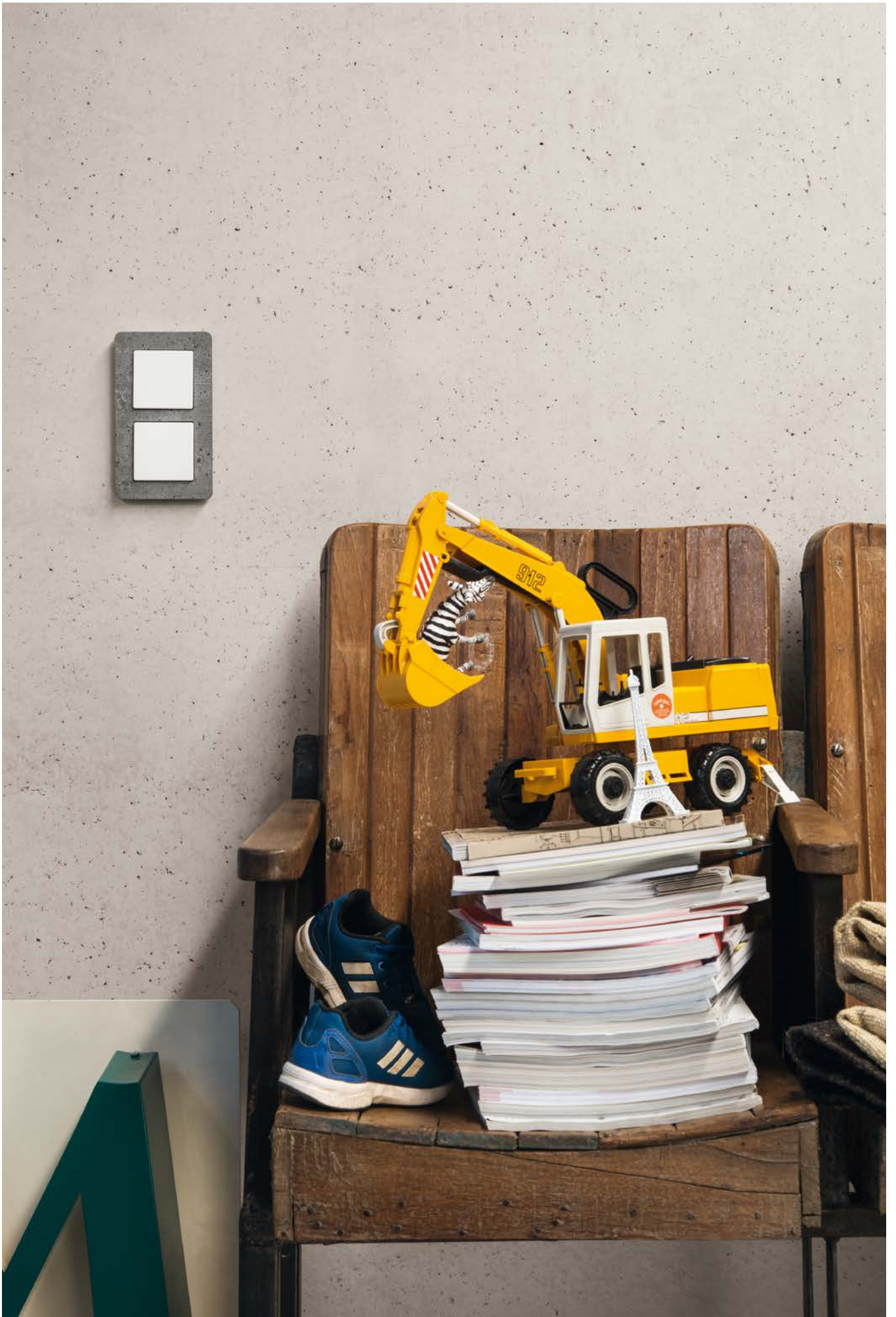

Q.7 Concrete

In modern architecture, concrete is increasingly gaining in significance as a design element. It is a favourite material among architects, who use it to create houses and spaces, which are minimalist but not cold. The Berker Q.7 in concrete incorporates this development and displays great attention to detail.



Material

4 mm textured concrete, 6 mm back plate material

Frame combinations

1-gang to 3-gang, horizontal / vertical

Rocker switches available in

anthracite velvet, polar white velvet, aluminium velvet

Q.7 Plastic

The Berker Q.7 in plastic emphasises functional elegance.

It is simple, neutral and a design statement.

The quality behind this modest design quickly becomes clear as you take in the details of the Berker Q.7 in plastic.

You can both see and feel the difference.

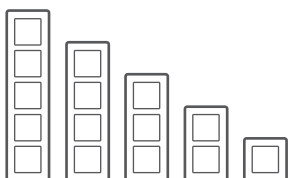

Material

4 mm polar white plastic, velvet, 6 mm back plate material

4 mm aluminium-coloured plastic, velvet, 6 mm back plate material

4 mm anthracite-coloured plastic, velvet, 6 mm back plate material

Frame combinations

1-gang to 5-gang, horizontal / vertical

Rocker switches available in

anthracite velvet, polar white velvet, aluminium velvet





Berker Q.1

Outer dimensions of frame
80.5 x 80.5 mm

**Outer dimensions
of rocker switch**
58 x 58 mm

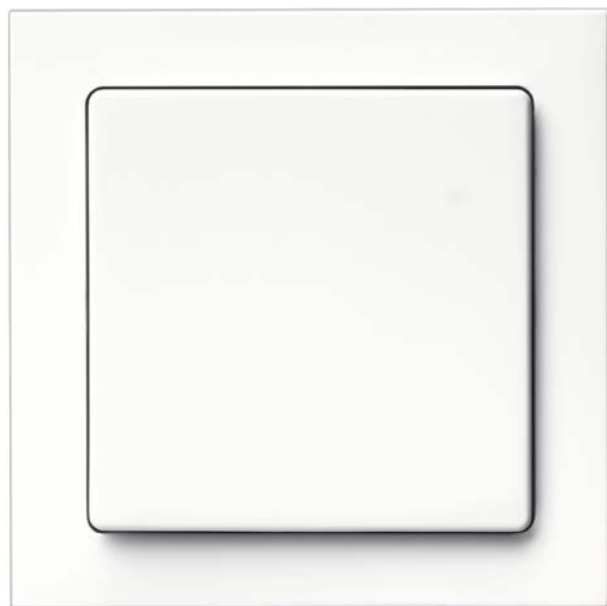

Berker Q.3

Outer dimensions of frame
80.5 x 80.5 mm

**Outer dimensions
of rocker switch**
58 x 58 mm



Berker Q.7

Outer dimensions of frame
95.2 x 95.2 mm

**Outer dimensions
of rocker switch**
58 x 58 mm

Major change, minimal effort.

As a member of the Q family of switches, the Berker Q.7 uses the same platform as the Q.1 and Q.3 design lines. This makes them easy to interchange. Simply remove the current Q family elements and place the frame of the Berker Q.7 on the existing inserts. It's as easy as that.



**The Berker Q.7 includes
a whole range of
possible combinations.**

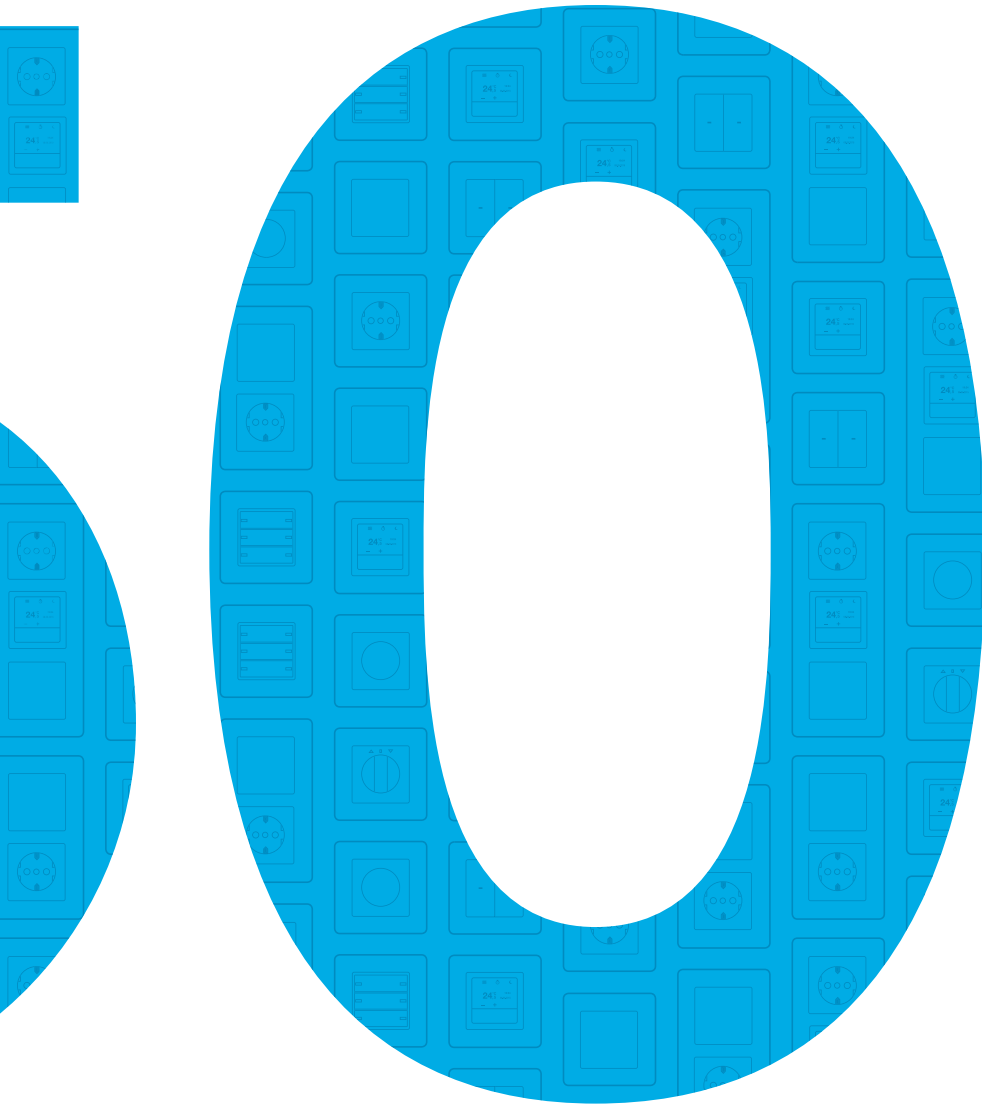

The Berker Q.7 uses the modular design of the Q family. This means you can not only choose between the frame materials – slate, concrete, aluminium, stainless steel, plastic or glass. Every material can also be combined with rocker switches and centre plates in colours anthracite, polar white or aluminium. Furthermore, frames are available in 1-gang to 5-gang configurations.

With over 250 variants, the extensive functionality of the new Berker Q.7 is equally diverse. The range extends from simple switches and practical – yet safety-essential – timer switches, to convenient tactile sensors for lights, blinds and shutters.

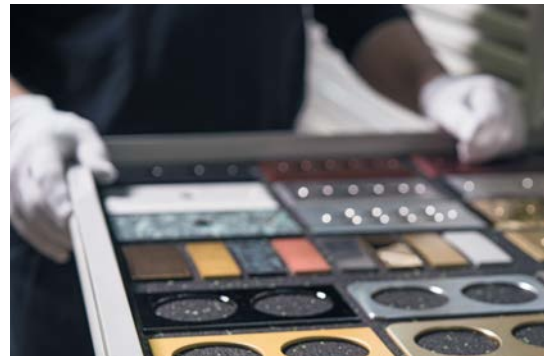

Manufactur

Even more unique requirements?

Discover our manufacturing service, which allows you to design your Berker Q.7 and everything it entails to make it even more tailor-made to your requirements.

Our manufacturing service typifies the state-of-the-art and uncomplicated process of custom-made production, with advice, planning and implementation all from a single source. In this context we offer a range of solutions from modified series products to tailor-made limited editions.

The manufacturing service produces perfectly coordinated solutions, from individually configured cable ducts to unique switches and control elements as well as compatible door communication.

In doing so, we use a variety of materials, colours, patterns and processing techniques – always in parallel with the individual requirements of the specific item. Moreover, every product is made in Germany. Naturally, the same quality requirements that apply to all our products and solutions also apply to our manufacturing service.

Finding your own individual solution is remarkably easy. Simply explain your requirements to your Hager representative, who will be happy to advise you on the configuration of your individual solution. Then, we will provide a binding quote of the costs and time required. If everything is in order, your solution will be put into production. We will then deliver your personal product on time.

For more information visit [hager.de/manufaktur](https://www.hager.de/manufaktur)

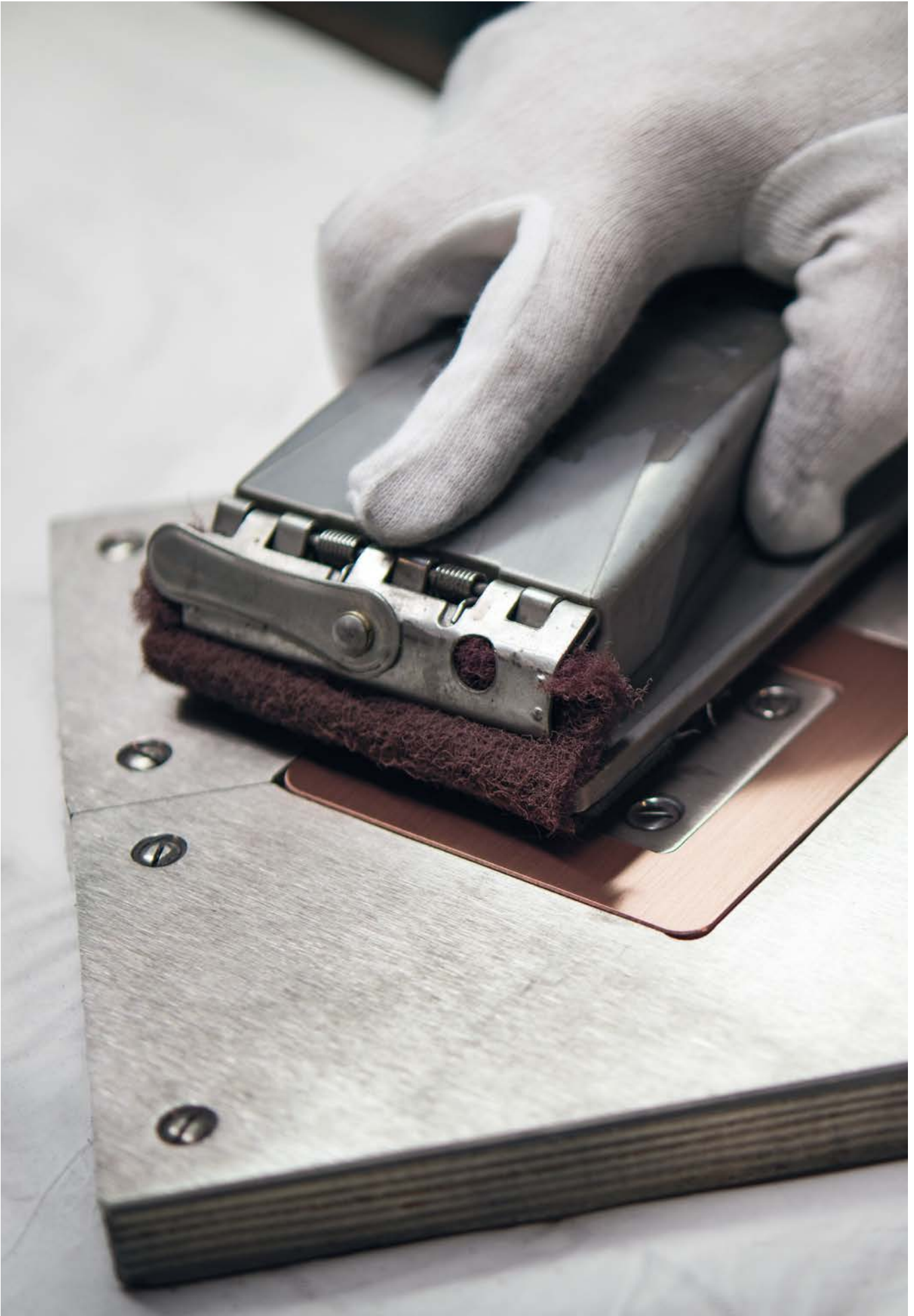

Example: Q.7 in brushed copper



Catalogue excerpt



Frames and surfaces

The geometric form of the Berker Q.7 switch series identifies it as a member of the Q family of switches at first sight.

As well as its exclusive materiality, this series is distinguished by its dimensions. The frame measures 95.2 mm x 95.2 mm and the centre plate is 58 mm.

The translucent back plate material with a thickness of 6 mm takes on the colour of its background, subtly pushing the 4-mm thick frame into the foreground.

- Manifold frame allows for the combination of up to five devices, horizontal or vertical
- Extensive functionality with over 250 variants
- Available finishes:
 - slate, concrete,
 - aluminium, stainless steel,
 - polar white glass, black glass,
 - polar white plastic, velvet,
 - anthracite plastic, velvet,
 - aluminium plastic, velvet



Frame

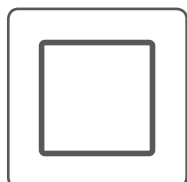

Frame available in the following materials:

Polar white glass

Black glass

Aluminium

Stainless steel

Slate

Concrete

Polar white plastic, velvet

Anthracite plastic, velvet

Aluminium plastic, velvet

similar to RAL 9010

similar to RAL 9005

anodised

brushed

natural

textured

similar to RAL 9010

similar to RAL 7021

similar to RAL 9006

Cover plates/ centre plates



Cover plates/centre plates available in plastic, velvet:

polar white

anthracite, painted

aluminium, painted

red

green

orange

similar to RAL 9010

similar to RAL 7021

similar to RAL 9006

similar to RAL 3003

similar to RAL 6029

similar to RAL 2003

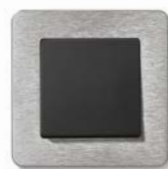

Dimensions

Material: polar white plastic, aluminium plastic, anthracite plastic, polar white glass, black glass, aluminium, stainless steel

1-gang frame

W 95.2 mm x H 95.2 mm

2-gang to 5-gang frames, horizontal

W 166.2 mm x H 95.2 mm, 2-gang
W 237.2 mm x H 95.2 mm, 3-gang
W 308.2 mm x H 95.2 mm, 4-gang
W 379.2 mm x H 95.2 mm, 5-gang

2-gang to 5-gang frames, vertical

H 166.2 mm x W 95.2 mm, 2-gang
H 237.5 mm x W 95.2 mm, 3-gang
H 308.2 mm x W 95.2 mm, 4-gang
H 379.2 mm x W 95.2 mm, 5-gang

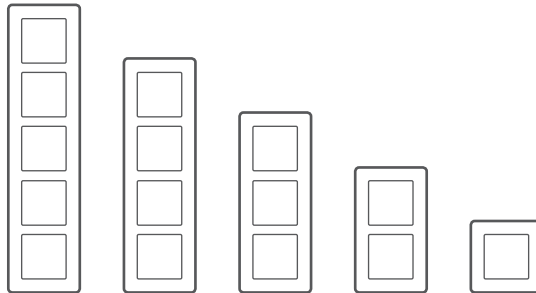

1.5-gang frame, vertical

H 154.2 mm x W 95.2 mm

Frames for Q.1/Q.3/Q.7 KNX operating units

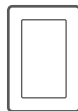

Material: slate, concrete

1-gang frame

W 95.2 mm x H 95.2 mm, 1-gang

2-gang to 3-gang frames, horizontal

W 166.2 mm x H 95.2 mm, 2-gang
W 237.2 mm x H 95.2 mm, 3-gang

2-gang to 3-gang frames, vertical

H 166.2 mm x W 95.2 mm, 2-gang
H 237.5 mm x W 95.2 mm, 3-gang

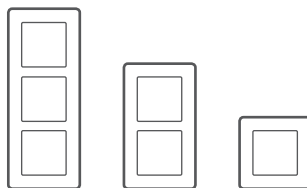

1.5-gang frame, vertical

H 154.2 mm x W 95.2 mm

Frames for Q.1/Q.3/Q.7 KNX operating units



Dimensional drawings

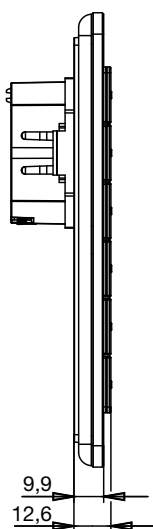
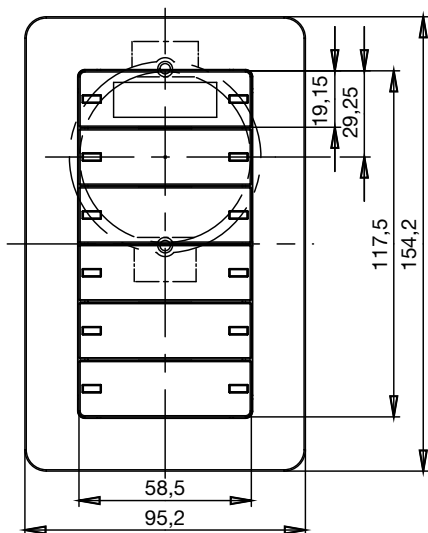
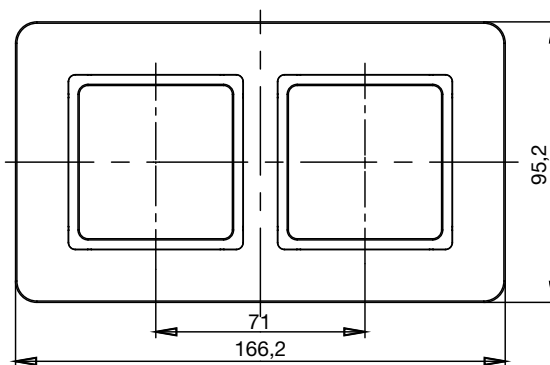
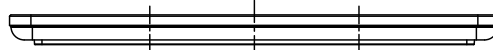
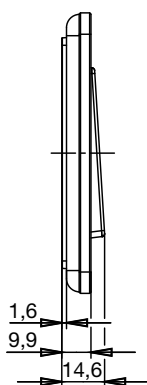
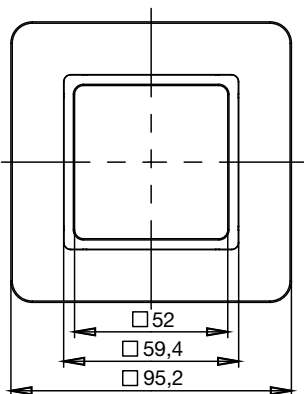
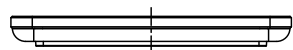



10116189

Frames, polar white velvet

- for vertical and horizontal mounting

| Designation | PU | Order no. |
|----------------------------|----|-----------------|
| polar white velvet, 1-gang | 10 | 10116189 |
| polar white velvet, 2-gang | 5 | 10126189 |
| polar white velvet, 3-gang | 5 | 10136189 |
| polar white velvet, 4-gang | 1 | 10146189 |
| polar white velvet, 5-gang | 1 | 10156189 |



10116186

Frames, anthracite velvet

- for vertical and horizontal mounting

| Designation | PU | Order no. |
|------------------------------------|----|-----------------|
| anthracite velvet, painted, 1-gang | 10 | 10116186 |
| anthracite velvet, painted, 2-gang | 5 | 10126186 |
| anthracite velvet, painted, 3-gang | 5 | 10136186 |
| anthracite velvet, painted, 4-gang | 1 | 10146186 |
| anthracite velvet, painted, 5-gang | 1 | 10156186 |



10116184

Frames, aluminium velvet, painted

- for vertical and horizontal mounting

| Designation | PU | Order no. |
|-----------------------------------|----|-----------------|
| Aluminium velvet, painted, 1-gang | 10 | 10116184 |
| Aluminium velvet, painted, 2-gang | 5 | 10126184 |
| Aluminium velvet, painted, 3-gang | 5 | 10136184 |
| Aluminium velvet, painted, 4-gang | 1 | 10146184 |
| Aluminium velvet, painted, 5-gang | 1 | 10156184 |



10116079

Frames, polar white glass

- for vertical and horizontal mounting

| Designation | PU | Order no. |
|---------------------------|----|-----------------|
| Polar white glass, 1-gang | 1 | 10116079 |
| Polar white glass, 2-gang | 1 | 10126079 |
| Polar white glass, 3-gang | 1 | 10136079 |
| Polar white glass, 4-gang | 1 | 10146079 |
| Polar white glass, 5-gang | 1 | 10156079 |

Frames, black glass

- for vertical and horizontal mounting

| Designation | PU | Order no. |
|---------------------|----|-----------------|
| Black glass, 1-gang | 1 | 10116076 |
| Black glass, 2-gang | 1 | 10126076 |
| Black glass, 3-gang | 1 | 10136076 |
| Black glass, 4-gang | 1 | 10146076 |
| Black glass, 5-gang | 1 | 10156076 |



10116076

Frames, blasted aluminium

- for vertical and horizontal mounting

| Designation | PU | Order no. |
|---------------------------|----|-----------------|
| Blasted aluminium, 1-gang | 1 | 10116074 |
| Blasted aluminium, 2-gang | 1 | 10126074 |
| Blasted aluminium, 3-gang | 1 | 10136074 |
| Blasted aluminium, 4-gang | 1 | 10146074 |
| Blasted aluminium, 5-gang | 1 | 10156074 |



10116074

Frames, brushed stainless steel

- for vertical and horizontal mounting

| Designation | PU | Order no. |
|---|----|-----------------|
| Brushed stainless steel, 1-gang | 1 | 10116083 |
| Brushed stainless steel, 2-gang, vertical | 1 | 10126083 |
| Brushed stainless steel, 3-gang, vertical | 1 | 10136083 |
| Brushed stainless steel, 4-gang, vertical | 1 | 10146083 |
| Brushed stainless steel, 5-gang, vertical | 1 | 10156083 |
| Brushed stainless steel, 2-gang, horizontal | 1 | 10226083 |
| Brushed stainless steel, 3-gang, horizontal | 1 | 10236083 |
| Brushed stainless steel, 4-gang, horizontal | 1 | 10246083 |
| Brushed stainless steel, 5-gang, horizontal | 1 | 10256083 |



10116083

Frames, natural slate

- for vertical and horizontal mounting

| Designation | PU | Order no. |
|---------------|----|-----------------|
| Slate, 1-gang | 1 | 10116030 |
| Slate, 2-gang | 1 | 10126030 |
| Slate, 3-gang | 1 | 10136030 |



10116030



10116020

Frame, textured concrete

- for vertical and horizontal mounting

| Designation | PU | Order no. |
|---------------------------|----|-----------------|
| Textured concrete, 1-gang | 1 | 10116020 |
| Textured concrete, 2-gang | 1 | 10126020 |
| Textured concrete, 3-gang | 1 | 10136020 |



13096074

Frame with a large cut-out

- for vertical mounting
- Not suitable for surface-mounted housing.

| Designation | PU | Order no. |
|---------------------------|----|-----------------|
| Polar white velvet | 1 | 13096189 |
| Anthracite velvet | 1 | 13096186 |
| Aluminium velvet, painted | 1 | 13096184 |
| Polar white glass | 1 | 13096079 |
| Black glass | 1 | 13096076 |
| Blasted aluminium | 1 | 13096074 |
| Brushed stainless steel | 1 | 13096083 |
| Slate | 1 | 13096030 |
| Textured concrete | 1 | 13096020 |

Inserts and attachments can be found at: hager.de/katalogQ.7

Product examples:

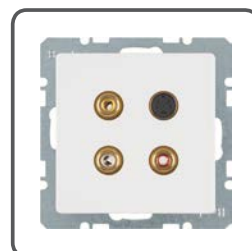
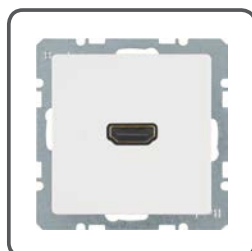
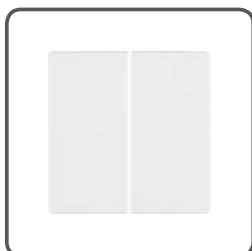
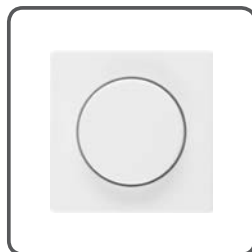

A large, bold, blue letter 'B' followed by a period, serving as a logo.

Berker

Berker has continually developed since its founding in 1919. Today, the long-established brand belongs to Hager Vertriebsgesellschaft.

It combines values that have evolved over the years with today's high standards in design and technology.

This ensures regular accolades from international juries and means that Berker continues to set new standards in terms of functionality, usability and quality.

Discover, experience and learn even more.

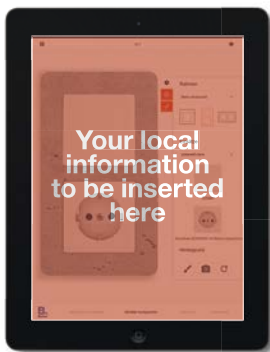

Berker switch app:

Get an idea of the possibilities of the new Berker Q.7 design line. With the Berker switch app you can go through all the possible material, function and colour variants and try them out on any background. The free app is available for Android tablets and iPads from Google Play, the App Store or at schalter.berker.de.

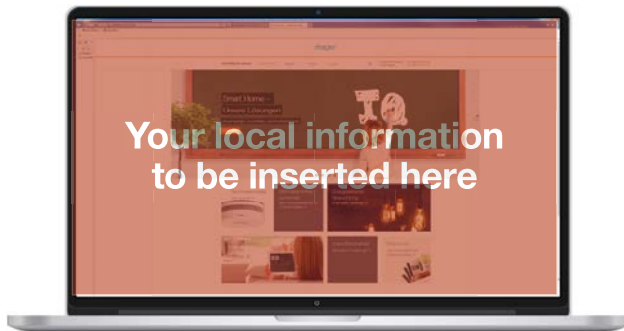

[das-intelligente-zuhause.de:](http://das-intelligente-zuhause.de)

At das-intelligente-zuhause.de you will find online advice for developers and modernisers. Smart home solutions from Hager, Berker and Elcom as well as a range of additional information and practical planning tips are all available on the website as supporting tools

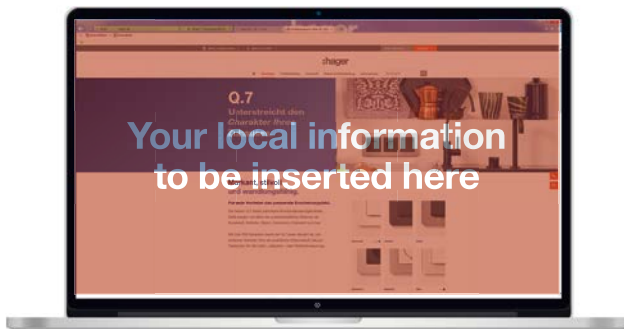

[hager.de/berkerQ.7:](http://hager.de/berkerQ.7)

Find all the information about the new Q.7 range of switches here.



Company name

Street

City, Postal code

Country

Telephone

hager.xx